



# 2020 Regulations

RELEASE A  
Jan 31, 2019

Organized by Innovators Educational Foundation

## Contents

<b>SECTION 1 - ADMINISTRATION .....</b>	<b>10</b>
<b>1. Purpose .....</b>	<b>11</b>
1.1 Fundamental Vision .....	11
1.2 Missions .....	11
<b>2. Administration .....</b>	<b>11</b>
2.1 American Solar Challenge Organizers.....	11
2.2 Headquarters.....	11
2.3 Officials.....	11
2.3.A Event Director .....	11
2.3.B Regulations Manager.....	11
2.3.C Chief Inspector / Clerk of Course.....	11
2.3.D Head Timekeeper .....	11
2.3.E Technical, Safety and Fairness Officials.....	12
2.3.F Jury .....	12
2.4 Application of Regulations.....	12
2.5 Supplemental Documents .....	12
2.5.A Additional Documents .....	12
2.5.B Conflict .....	12
2.6 Acceptance of Regulations .....	12
2.7 Interpretation of Regulations .....	13
2.7.A Interpretation.....	13
2.7.B Official / Unofficial Interpretations .....	13
2.7.C Prior to Scrutineering .....	13
2.7.D During and after Scrutineering.....	13
2.8 Advertising, Promotion, and Publicity .....	13
<b>3. Safety.....</b>	<b>14</b>
3.1 Team Safety.....	14
3.1.A Team Safety Officer.....	14
3.1.B Team Safety Kit .....	14
<b>4. Entries .....</b>	<b>15</b>
4.1 Entry Registration.....	15
4.1.A Registration - Initial Registration Package.....	15
4.1.B Registration – Track Registration Package .....	15
4.1.C Registration – Road Registration & Fee .....	15
4.1.D Grants .....	15
4.1.E Donations.....	15
4.1.F Team Members.....	15
4.1.G Supporters and Additional Team Members .....	15
4.2 Team Data.....	16
4.2.A Team Photo .....	16
4.2.B Data Sheets .....	16
4.3 Registration Deadlines .....	16
4.3.A Registration Dates .....	16
4.3.B Late Penalties .....	16
4.3.C Entry Fee Payments .....	17
4.4 University/College Advisor .....	17
4.4.A University/College Advisor.....	17
4.5 Communication between ASC Headquarters and Teams .....	17
4.5.A Team Members.....	17
4.5.B Emails .....	17
4.6 Insurance.....	17
4.7 Withdrawals and Exclusion .....	18
4.7.A Voluntary.....	18
4.7.B Not Meeting Requirements .....	18
4.7.C Exclusion.....	18
4.8 Solar Car Numbers: .....	18
4.9 Participant Registration .....	18

<b>5. Technical Documentation .....</b>	<b>19</b>
5.1 Preliminary Vehicle Design Report (PVDR) .....	19
5.1.A PVDR Contents .....	19
5.2 Vehicle Design Report (VDR) .....	19
5.2.A Document Format .....	19
5.2.B Mechanical Technical Report .....	19
5.2.C Electrical System Technical Report .....	20
5.2.D Battery Tech Report .....	20
5.2.E Battery Protection Tech Report: .....	20
5.2.F Solar Cell Tech Report .....	21
5.3 Grading of Team Reports .....	21
5.4 Professional Engineer Signoff .....	21
<b>6. Event Components .....</b>	<b>22</b>
6.1 Scrutineering .....	22
6.1.A Acceptance at Scrutineering .....	22
6.1.B Participation at Scrutineering .....	22
6.1.C Scrutineering Time and Location .....	22
6.1.D Scrutineering Format .....	22
6.1.E Configuration and Drivers for Scrutineering .....	22
6.2 Qualifier .....	22
6.2.A Participation at Qualifier .....	22
6.2.B Acceptance at Qualifier .....	22
6.3 The Tour .....	22
<b>7. Vehicle Classes .....</b>	<b>23</b>
7.1 Vehicle Class Definitions .....	23
7.1.A Single-Occupant .....	23
This class comprises solar powered vehicles designed for a single-occupant. These vehicles are akin to the “Challenger” class of vehicles from the 2019 Bridgestone World Solar Challenge. ....	23
7.1.B Multi-Occupant .....	23
This class comprises solar powered and grid-charge vehicles designed for multiple-occupants. These vehicles are akin to the “Cruiser” class of vehicle from the 2019 Bridgestone World Solar Challenge. ....	23
7.1.C Grandfathered .....	23
<b>SECTION 2 – TECHNICAL .....</b>	<b>24</b>
<b>8. Power .....</b>	<b>25</b>
8.1 Solar Collector .....	25
8.1.A Cell Type .....	25
8.1.B Solar Collector Size Limits .....	25
8.1.C Definition of Area .....	25
8.1.D Concentrators .....	25
8.1.E Hybrid Solar Collectors .....	25
8.1.F Maximum Number of Cell Types and Sizes .....	25
8.1.G Validation Documentation .....	25
8.1.H Solar Collector Connection and Stands .....	25
8.1.I Water Spray .....	26
8.1.J Solar Collector Reconfiguration .....	26
8.1.K External Irradiance Amplification .....	26
8.2 Energy Storage .....	26
8.2.A Battery Weight Limits .....	26
8.2.B Other Energy Storage Methods .....	26
8.2.C Supplemental Batteries .....	26
8.2.D Other Storage Devices .....	26
8.3 Protection Circuitry .....	27
8.3.A Definitions .....	27
8.3.B Types .....	27
8.4 Battery Enclosures .....	28
8.4.A Isolation .....	28
8.4.B Mounting .....	28
8.4.C Marking .....	28

8.4.D	Ventilation .....	28
8.4.E	External Cooling.....	28
8.4.F	Security .....	28
8.4.G	Impound Box.....	28
8.5	Main Fuse.....	29
8.5.A	Main .....	29
8.5.B	Branch.....	29
8.5.C	Voltage Taps.....	29
8.6	Power Switch.....	29
8.6.A	Main Power Switch .....	29
8.6.B	BPS Fault Dash Indication .....	29
8.6.C	External Power Cut Off Switch .....	29
8.7	Cables .....	30
8.7.A	Cable Sizing.....	30
8.8	Control.....	30
8.8.A	Sole Control .....	30
8.8.B	Accelerator.....	30
8.8.C	Cruise Control .....	30
8.9	Electrical Shock Hazards .....	30
8.10	Multi-occupant Vehicle Charging and Metering .....	30
	Charging and Metering .....	30
8.10.A	30	
	Charging and Safety .....	30
8.10.B	30	
	Charging Adapter.....	30
8.10.C	30	
<b>9.</b>	<b>Solar Car Body.....</b>	<b>31</b>
9.1	Solar Car Dimensions .....	31
9.2	Driving Configuration.....	31
9.3	Ground Clearance .....	31
9.4	Lighting.....	31
9.4.A	Daytime Running Lights / Headlamps .....	31
9.4.B	Front Turn Indicators.....	31
9.4.C	Side Marker Turn Indicators .....	31
9.4.D	Rear Brake Lights .....	32
9.4.E	Rear Turn Indicators .....	32
9.4.F	High Mounted Brake Light .....	32
9.4.G	BPS Fault Indicator .....	32
9.4.H	Emergency Hazard .....	32
9.4.I	Horn .....	32
9.5	Visibility .....	33
9.5.A	Eye Height .....	33
9.5.B	Forward and Sideward Vision .....	33
9.5.C	Windshield .....	33
9.5.D	Rain Clearing .....	33
9.5.E	Rear Vision .....	33
9.5.F	Outside Air Circulation .....	33
9.6	Egress .....	34
9.6.A	Performance Requirement.....	34
9.6.B	Occupant Cockpit and Opening.....	34
9.7	Ballast.....	34
9.7.A	Ballast Bag.....	34
9.7.B	Ballast Box .....	34
9.7.C	Common Ballast.....	35
9.7.D	Ballast Access.....	35
9.7.E	Ballast Type .....	35
9.8	Data Logger.....	35
9.9	Solar Car Markings .....	35
9.9.A	Solar Car Numbers .....	35
9.9.B	Institution Name(s) & Sponsors .....	35

9.9.C	Event Logo.....	35
9.9.D	National Flag.....	36
9.9.E	Front Signage .....	36
<b>10.</b>	<b>Mechanical .....</b>	<b>37</b>
10.1	Body Panels .....	37
10.1.A	Covers and Shields.....	37
10.1.B	Clearance.....	37
10.1.C	Array Attachment .....	37
10.2	Tire and Wheel Requirements .....	37
10.2.A	Wheel Configuration .....	37
10.2.B	Design Intent.....	37
10.2.C	Tires.....	37
10.2.D	Wheels/Rims.....	37
10.3	Cockpit .....	38
10.3.A	Occupant Cell .....	38
10.3.B	Occupant Seats .....	39
10.3.C	Occupant Space .....	39
10.3.D	Belly Pan.....	39
10.3.E	Safety Belts.....	39
10.4	Fasteners .....	42
10.4.A	Bolts.....	42
10.4.B	Securing of Fasteners.....	42
10.4.C	Securing Rod Ends.....	42
10.4.D	Buckles and Straps.....	42
10.4.E	Critical Areas.....	42
10.5	Brakes.....	43
10.5.A	Configuration.....	43
10.5.B	Brake Pads .....	43
10.5.C	Braking Performance.....	43
10.5.D	Brake Lines/Cables.....	43
10.5.E	Clearance between Pedals.....	43
10.5.F	Hand Activated Brakes .....	43
10.5.G	Cars with Mechanical Rear Brake .....	43
10.6	Parking Brake.....	43
10.6.A	Performance .....	43
10.6.B	Independence .....	44
10.6.C	Locking.....	44
10.6.D	Contact Style.....	44
10.7	Steering.....	44
10.7.A	Steering Wheel .....	44
10.7.B	Steering Stops .....	44
10.7.C	Turning Radius.....	44
10.7.D	Steering Backlash.....	44
10.8	Towing Hardpoint.....	44
10.9	Dynamic Stability.....	45
10.9.A	Figure-8.....	45
10.9.B	Stability at Speed.....	45
10.9.C	Slalom Test.....	45
10.9.D	Brake Test.....	45
10.9.E	Disqualification of a Driver .....	45
<b>11.</b>	<b>Occupant Requirements .....</b>	<b>46</b>
11.1	Occupant Registration.....	46
11.1.A	Drivers.....	46
11.1.B	Passengers.....	46
11.2	Occupant Weight and Ballast.....	46
11.2.A	Occupant Weight .....	46
11.2.B	Occupant Ballast.....	46
11.3	Helmets .....	46
11.4	Shoes.....	46

11.5	Duration in Car .....	46
11.6	Water/Fluids .....	46
11.7	Driver Communication.....	47
11.7.A	Driver Communications.....	47
11.7.B	Cell Phone Use .....	47
11.7.C	Solar Vehicle Driver Communication .....	47
<b>SECTION 3 – OPERATIONS .....</b>		<b>48</b>
<b>12.</b>	<b>Tour .....</b>	<b>49</b>
12.1	Format.....	49
12.2	Determination of Winner .....	49
12.2.A	Single-Occupant Vehicles .....	49
12.2.B	Multi-Occupant Vehicles .....	49
12.3	Solar Car Configuration.....	49
12.4	Support Vehicles .....	49
12.4.A	Drivers.....	49
12.4.B	Lead Vehicle .....	49
12.4.C	Chase Vehicle.....	49
12.4.D	Scout Vehicle .....	50
12.4.E	Other Support Vehicles.....	50
12.4.F	Support Vehicle Graphics .....	50
12.5	Radios / Communication .....	50
12.5.A	Observer Monitoring .....	50
12.5.B	Driver Communications.....	50
12.6	Observers.....	51
12.6.A	Observer Access for Inspection.....	51
12.6.B	Observer Record of Performance.....	51
12.6.C	Observer Accommodations.....	51
12.7	Team Uniforms.....	51
12.7.A	Solar Car Occupants Attire .....	51
12.8	Briefings .....	51
12.9	Timing.....	52
12.9.A	Responsibility .....	52
12.9.B	Official Elapsed Time and Official Distance.....	52
12.9.C	Official Elapsed Segment Time and Segment Distance.....	52
12.9.D	Team Off-Course .....	52
12.10	Tour Hours .....	52
12.10.A	Standard Tour Day.....	52
12.10.B	Time Zones .....	52
12.11	Tour Route .....	53
12.11.A	Route Book .....	53
12.11.B	Route Revisions .....	53
12.11.C	Teams Departing from the Tour Route .....	53
12.11.D	Emergency Route Revisions .....	53
12.12	Stage Starts.....	53
12.12.A	Starting Order .....	53
12.12.B	Teams Not Ready .....	53
12.12.C	Official Start Time .....	53
12.12.D	Delayed Start .....	54
12.12.E	Stage Start Timing Adjustment .....	54
12.13	Non-Stage Starts.....	54
12.14	Checkpoints.....	54
12.14.A	Active Checkpoints .....	54
12.14.B	Solar Car Maintenance .....	54
12.14.C	Closed Checkpoints .....	54
12.14.D	End of Day at Checkpoint .....	54
12.15	Overnight Stops .....	54
12.16	Stage Finishes.....	55
12.16.A	Teams Arriving After the Stage Finish is Closed .....	55
12.17	Impound .....	55

12.17.B Impound Times .....	55
12.17.C Impound Rules at Stage Locations .....	55
12.18 Charging Areas .....	56
12.18.A Staged Stop .....	56
12.18.B Non-Staged Stop .....	56
12.19 Passing Traffic.....	56
12.19.A In Traffic .....	56
12.20 Traffic Laws .....	56
12.21 Passing Teams.....	56
12.22 Drafting.....	56
12.23 Pushing .....	56
12.23.A Checkpoints / Stage points .....	56
12.23.B Emergency.....	56
12.23.C Weather.....	56
12.23.D Penalties .....	56
12.24 Trailering .....	57
12.24.A Pushing .....	57
12.24.B Battery Charging .....	57
12.24.C Trailering to Checkpoints or Stage .....	57
12.24.D Resumption of Driving.....	57
12.24.E Resumption of Driving at a Checkpoint .....	57
12.25 Accommodations and Lodging.....	57
12.26 Accidents and Re-Inspection .....	57
12.27 Alterations and Repairs.....	57
<b>13. Multi-Occupant Vehicle Judging .....</b>	<b>58</b>
13.1 Goal.....	58
Scoring .....	58
13.2 58	
Multi-occupant vehicle teams will be ranked according to their S value (highest score is best). .....	58
$S = D / E \times P \times C$ .....	58
If a team's Overall Average Speed is below the Target Average Speed, their score will be multiplied by.....	58
$0.4^{(V-V_a)}$ 58	
Where V is the Target Average Speed and $V_a$ is the Overall Average Speed.....	58
13.2.A External Energy Usage .....	58
Total External Energy usage of a Multi-occupant vehicle will be calculated as: .....	58
$(n+1) \times Q + M$ .....	58
Where n is the number of times unmetered external energy is used to charge the vehicle between the start line and the finish line, and Q is the nominal energy capacity of the energy storage system, and M is the total metered external energy in kWh used to charge the vehicle. The nominal energy capacity of a rechargeable electrochemical battery is the sum of the nominal cell masses in kilograms (kg) multiplied by: .....	58
0. 58	
330 kWh/kg for Li-S cell .....	58
0. 58	
250 kWh/kg for Li-ion cell .....	58
0. 58	
250 kWh/kg for Li-polymer cell .....	58
0. 58	
125 kWh/kg for LiFePO4 cells.....	58
13.2.B Person-Mile Distance.....	58
13.2.C Completion Factor.....	59
13.2.D Average Speed .....	59
13.2.E Practicality Score .....	59
13.3 Route.....	59
13.3.A Completing the Route .....	59
13.3.B Checkpoints and Stage Stops .....	59
13.4 Solar Car Configuration.....	59
<b>14. FSGP/Qualifier Operations.....</b>	<b>60</b>
14.1 Track Event Format.....	60
14.2 Determination of Winner .....	60

14.2.A	Single-Occupant Vehicle.....	60
14.2.B	Multi-Occupant Vehicle .....	60
14.3	Solar Car Configuration.....	60
14.4	Radios / Communication .....	60
14.5	Authority .....	60
14.6	Safety .....	60
14.6.A	Safety Equipment.....	60
14.6.B	Support Vehicles.....	60
14.6.C	Safety Vehicles .....	60
14.7	Briefings .....	61
14.8	Timing.....	61
14.8.A	Responsibility .....	61
14.8.B	Timers .....	61
14.8.C	Official Time .....	61
14.8.D	Track Hours .....	61
14.9	Starts .....	61
14.9.A	Group Start .....	61
14.9.B	Starting Order .....	61
14.9.C	Start Line.....	61
14.9.D	Delayed Start .....	61
14.10	End of Day.....	62
14.10.A	End of Day .....	62
14.11	Required Laps for ASC Qualification .....	62
14.11.A	Team Qualification .....	62
14.11.B	Driver Qualification.....	62
14.11.C	Discretion .....	62
14.12	Charging/Impound.....	62
14.12.A	Charging.....	62
14.12.B	Impounding .....	62
14.13	Driving Procedures.....	63
14.13.A	Speed Limit .....	63
14.13.B	Following Too Closely.....	63
14.13.C	Pushing .....	63
14.14	Breakdowns.....	63
14.15	Track Operation.....	63
14.15.A	Flags .....	63
<b>15.</b>	<b>Penalties.....</b>	<b>65</b>
15.1	Penalty Times/Distance/Laps.....	65
15.1.A	Penalty Times/Distance (Tour) .....	65
15.1.B	Penalty Laps (Track Event).....	65
15.1.C	Scrutineering Issues .....	65
15.1.D	Posting of Penalties (Tour) .....	65
15.1.E	Posting of Penalties (Track Event) .....	65
15.2	Protests .....	65
15.2.A	Opportunity to Be Heard .....	65
15.2.B	Time Limit (Tour).....	66
15.2.C	Time Limit (Track Event).....	66
15.2.D	Protest Judgements .....	66
15.3	Conduct.....	66
15.4	Penalties.....	66
15.4.A	Speeding .....	66
15.4.B	Traffic Violations .....	66
15.4.C	Failure to Allow Other Traffic or Solar car to Pass .....	67
15.4.D	Support Vehicles Impeding Tour .....	67
15.4.E	Drafting.....	67
15.4.F	Pushing .....	67
15.4.G	Improper Ballast.....	67
15.4.H	Unauthorized Drivers / Occupants.....	67
15.4.I	Driving Outside of the Event Day.....	67
15.4.J	Non-Solar Charging of Batteries.....	67



---

15.4.K	Disturbing Official Battery Seals .....	67
15.4.L	Replacement of Batteries.....	68
15.4.M	Failure to Impound .....	68
15.4.N	Exceeding Size Specifications .....	68
15.4.O	Securing of Fasteners.....	68
15.4.P	Parking Brake Penalty .....	68
15.4.Q	Roll Cage Clearance Penalty.....	68
15.4.R	Overweight Battery Penalty .....	68
15.4.S	Ignoring BPS Fault Indicator.....	68
<b>Appendix A.</b>	<b>Steering Wheel Specifications .....</b>	<b>69</b>
<b>Appendix B.</b>	<b>Occupant Space Diagram.....</b>	<b>70</b>
<b>Appendix C.</b>	<b>Reference Standard for Lighting .....</b>	<b>71</b>
<b>Appendix D.</b>	<b>PVDR - Instructions .....</b>	<b>72</b>
<b>Appendix E.</b>	<b>Mechanical PVDR Form .....</b>	<b>73</b>
<b>Appendix F.</b>	<b>Mechanical Report Instructions .....</b>	<b>74</b>
<b>Appendix G.</b>	<b>Mechanical VDR Form .....</b>	<b>76</b>
<b>Appendix H.</b>	<b>Battery Approval Form .....</b>	<b>78</b>
<b>Appendix I.</b>	<b>Solar Cell Report .....</b>	<b>79</b>
<b>Appendix J.</b>	<b>Solar Cell Approval Form.....</b>	<b>80</b>
<b>Appendix K.</b>	<b>Recommendations.....</b>	<b>81</b>
<b>Appendix L.</b>	<b>Multi-occupant Vehicle Practicality Judging.....</b>	<b>82</b>
<b>Appendix M.</b>	<b>Revision Table .....</b>	<b>83</b>

# **SECTION 1 - ADMINISTRATION**

# 1. Purpose

## 1.1 Fundamental Vision

The American Solar Challenge (ASC), hosted by the Innovators Educational Foundation (IEF), seeks to promote and celebrate educational excellence and engineering creativity. Fueled by the spirit of friendly competition and teamwork, the ASC champions the creative integration of technical and scientific expertise across a range of exciting disciplines.

## 1.2 Missions

To support and encourage bright young minds to succeed in the technical fields of engineering, the sciences, mathematics, and business, through multi-disciplined experiential learning which in turn enables success in future careers.

To create public awareness and enthusiasm, both for education excellence and engineering creativity itself, and for the technologies and practices that emerge from that excellence.

# 2. Administration

## 2.1 American Solar Challenge Organizers

The Innovators Educational Foundation (IEF) shall be the official Organizers of the American Solar Challenge (the "Event"), and shall be responsible for all management oversight and application of the regulations for the Event.

## 2.2 Headquarters

During the Event, a Headquarters will be established at a site appropriate to each Event component and will assume the management functions for the Event.

## 2.3 Officials

A team of Officials to conduct the Event including all event components will be selected by American Solar Challenge Organizers. Officials having specific duties shall be announced to the teams through the briefings.

### 2.3.A Event Director

The American Solar Challenge Organizers will appoint an Event Director who has responsibility for the Event.

### 2.3.B Regulations Manager

The American Solar Challenge Organizers will appoint an individual for the role of the Regulations Manager. The Regulations Manager reports to the Event Director, and to the Organizers and is responsible for the regulations of the Event.

### 2.3.C Chief Inspector / Clerk of Course

The American Solar Challenge Organizers will appoint an individual to serve in the role of the Chief Inspector / Clerk of Course. The Chief Inspector / Clerk of Course reports to the Event Director, and to the Organizers and is responsible for the technical inspections of the solar cars and enforcement of the Regulations.

### 2.3.D Head Timekeeper

The American Solar Challenge Organizers will appoint an individual to serve in the role of Head Timekeeper. The Head Timekeeper reports to the Chief Inspector, and to the Organizers and is responsible for the timing and scoring during both Track and Tour portions of the event.

### **2.3.E Technical, Safety and Fairness Officials**

The Event Director, Chief Inspector, Regulations Manager and Head Timekeeper will appoint additional Officials to conduct the Event.

**2.3.E.1 Inspectors:** Several Officials will be assigned the role of “Inspector” who have the responsibility to perform technical inspections of the solar cars and enforce the Regulations.

**2.3.E.2 Observers:** During the cross-country portion of the Event a team of “Observers” will monitor the progress of the teams and report back to the Inspectors.

**2.3.E.3 Staff:** A team of “Staff” will support the Event and will be Officials during the Event.

**2.3.E.4 Track Steward:** During the track portion of the Event, an Official will be named the “Track Steward”. The Track Steward will be in control over operations of the track. The Track Steward will have the same authority as the Chief Inspector for track operation.

### **2.3.F Jury**

A Jury will be formed to evaluate protests on conformity with these Regulations, to resolve team disputes, and rule on penalty appeals. In addition, the Jury is empowered to decide cases not specifically covered by these Regulations. The Jury will be available to teams during the Event. Jury meetings will be held in private. A representative of the team(s) involved may attend deliberations concerning disputes regarding their team to give evidence and respond to questions from the jury, but not the vote. A representative of the Event may attend deliberations to give evidence and respond to question from the jury, but not the vote. The Jury will consist of a minimum of three (3) distinguished individuals who have experience with solar car events.

## **2.4 Application of Regulations**

These Regulations will apply to the American Solar Challenge, which includes the selection of teams, registration of teams, the inspection of solar cars (“Scrutineering”), the qualification of solar cars (the “Qualifier”), and the cross-country drive (the “Tour”).

## **2.5 Supplemental Documents**

### **2.5.A Additional Documents**

Additional documents may be distributed to all teams entered in the Event to supplement these Regulations. These documents will clearly state that they are a supplement to the Regulations and they will have the same force and effect as these Regulations.

### **2.5.B Conflict**

If there is a conflict between a supplemental document and these Regulations, the document having the later date shall take precedence. The Organizers reserve the right to revise these Regulations at any time.

## **2.6 Acceptance of Regulations**

All persons or groups selected to participate in the Event are assumed to know these Regulations. Their participation in the Event will constitute acceptance of them.

## 2.7 Interpretation of Regulations

### 2.7.A Interpretation

Only the Regulations Manager, Chief Inspector/Clerk of Course, and Inspectors are authorized to interpret the regulations.

### 2.7.B Official / Unofficial Interpretations

**2.7.B.1** Teams shall identify if their question constitutes an Official or Unofficial Interpretation.

**2.7.B.2** Official Interpretations will be responded to such that all teams will have visibility to the question and response.

**2.7.B.3** Official Interpretations will have the same force and effect as the Regulations.

**2.7.B.4** Unofficial Interpretations of the regulations will be kept private between the team and the Inspectors.

**2.7.B.5** Unofficial Interpretations will have no force and effect on the Regulations and may be superseded.

### 2.7.C Prior to Scrutineering

**2.7.C.1** Teams requesting interpretation of the Regulations shall submit their question(s) to the Inspectors through email at: [ascregs@americansolarchallenge.org](mailto:ascregs@americansolarchallenge.org)

**2.7.C.2** All Official Interpretations will be posted to the Internet under "Official Interpretations" on the ASC website.

### 2.7.D During and after Scrutineering

**2.7.D.1** All Official Interpretations will be announced at Briefings as well as on the Internet.

## 2.8 Advertising, Promotion, and Publicity

All advertising, sales promotion, and publicity material produced by the teams or their sponsors concerning or referring to the Event will refer prominently to the Event as "The American Solar Challenge". If in fact a naming sponsor is secured, teams will be required to append the Sponsor Name and to display the entire Event name, i.e. "The Acme - American Solar Challenge". All teams, by entering the Event, specifically agree to abide by this regulation. By entering the Event, all teams and team members agree to the use of their names and their likenesses in any publicity materials (brochures, magazines, videos, photographs, etc.) that may be issued by the Event's sponsors or organizers.

## 3. Safety

Each team is responsible for the road-worthiness of its solar car. Passing Event components of Scrutineering and the Qualifier or implementing changes suggested in comments on the team's technical documents does not relieve the team of any liability.

All solar cars and support vehicles must be maintained in a safe, road-worthy condition and be operated safely and within the law at all times. A team may be disqualified and withdrawn from the Event at any time if it is judged to be operating in an unsafe manner. All solar cars and support vehicles are operated and driven at the team's own risk.

Each team is responsible for the safety of its members, and any minimum criteria specified by the Organizers via these regulations and/or correspondence between the teams and the Organizers should not be construed as design specifications for the construction of a "safe" solar vehicle.

Teams must look after the health and safety of their team members.

### 3.1 Team Safety

#### 3.1.A Team Safety Officer

**3.1.A.1** Each team is required to have at least one Safety Officer.

**3.1.A.2** All Safety Officers shall be trained in basic First Aid including CPR. Proof of training shall be submitted to ASC Headquarters with their Team Data Sheet (available on the Event website).

**3.1.A.3** At all times, one of the team's Safety Officers must be the Designated Safety Officer. The Designated Safety Officer may not hold the role of Solar Car Driver, Support Vehicle Driver, or Team Manager while acting as the Designated Safety Officer. The Designated Safety Officer must travel in the Lead or Chase Vehicles while the Solar Car is on the road.

*It is encouraged to have more than one team member who is trained in basic First Aid including CPR.*

#### 3.1.B Team Safety Kit

**3.1.B.1** Each team shall have available the following safety kit:

- (1) Certified stocked first-aid kit;
- (2) ABC fire extinguisher (10 kg<sup>1</sup> or larger);
- (3) Safety vests (1 per occupant);
- (4) Four (4) orange cones (minimum 300 mm high);
- (5) Two (2) orange warning flags;
- (6) Battery MSDS;
- (7) Battery spill kit / method of containment of battery fires / 40 kg of sand;
- (8) A shovel/spade (for applying the sand);
- (9) Safety glasses and gloves for handling batteries; and,
- (10) Suitable containers for damaged electrochemical cells.

**3.1.B.2** The above safety kit shall be distributed among the applicable support vehicles during the Tour, and shall be located at the pit while the solar car is on the track for the Qualifier.

**3.1.B.3** The team shall ensure that applicable Personal Protective Equipment (PPE) is used for fabrication, repairs etc., i.e. safety glasses, cut resistant gloves etc.

---

<sup>1</sup> The 10 kg fire extinguisher can be comprised of two (2) 5 kg fire extinguishers

## 4. Entries

### 4.1 Entry Registration

The Event is open to institutions of higher education (participants). No entry / team will be considered registered until all items below are received by ASC Headquarters.

#### 4.1.A Registration - Initial Registration Package

**4.1.A.1** Each team wishing to participate in the Event must initially submit a registration package consisting of:

- (1) Team Entry Form;
- (2) Team Participation Agreement;
- (3) Proof of Insurance;
- (4) Preliminary Vehicle Design Report (as described in Reg. 5.1); and,
- (5) The initial entry fee, US\$1500.

**4.1.A.2** This portion of the entry fee is non-refundable.

#### 4.1.B Registration – Track Registration Package

**4.1.B.1** Each team participating in the Event must submit a track registration package consisting of:

- (1) Vehicle Design Report (as described in Reg. 5.2); and,
- (2) the track fee, US\$3250.

**4.1.B.2** This registration package is required for all teams planning to compete in Formula Sun Grand Prix (FSGP).

**4.1.B.3** All teams wishing to participate in ASC must also participate in FSGP as the qualifier.

**4.1.B.4** This portion of the entry fee is non-refundable.

#### 4.1.C Registration – Road Registration & Fee

**4.1.C.1** Teams planning to compete in the ASC must also pay a road fee of US\$3250.

**4.1.C.2** Teams desiring to only participate in FSGP do not need to pay this fee.

**4.1.C.3** This fee is partially refundable if the team withdraws from the Event. US\$2000 will be refunded if written notification is submitted to and confirmed by ASC Headquarters no later than the date listed in Reg. 4.3.A.4. No refunds will be made after that date.

#### 4.1.D Grants

Teams with demonstrated financial need, and technical potential, may apply for a grant from the Event organizers to cover all or part of the entry fees. Grants are limited to the Road Registration Fee portion only. Teams will be required to submit a proposal outlining their request and reasoning for requesting a Grant. The form of proposal will be provided to the team upon request. Award of a Grant is at the discretion of the Organizers.

#### 4.1.E Donations

Teams that withdraw after making payment will have funds considered as donations to the Innovators Educational Foundation in consideration that no services or goods are provided for said funds.

#### 4.1.F Team Members

The entry fees consider up to fifteen (15) team members.<sup>2</sup> Beyond this number an additional fee of \$60 per additional team member will be assessed.

#### 4.1.G Supporters and Additional Team Members

The American Solar Challenge Organizers reserve the right to determine if any individual is acting de facto as part of a team.

---

<sup>2</sup> It is understood that team members may arrive and depart from the Event at various times. The number of team members listed in the regulation is the total number registered, not the number of team members attending at any one time.

## 4.2 Team Data

Each team must submit a team photo and data sheet to ASC Headquarters by the date in Reg. 4.3.A.5. The photo and data can be publicly released and used in Event brochures. Late submissions will be omitted. Early submissions will not be made public prior to the date in Reg. 4.3.A.6 without permission of the team representative. After this date team information will be can be released by ASC Headquarters.

### 4.2.A Team Photo

Each team shall provide a digital team photo that must clearly show the solar car and team members. Team members in the photo must be identified by name and by their institution when there is more than one institutional sponsor. The photos will be used in the Event programs and other publications. In addition to the photo, teams must submit a filled-out Team Photo form which can be downloaded from the Team Status Board on the ASC Website.

### 4.2.B Data Sheets

Each team shall provide a data sheet which must include solar car weight (road-ready, without driver), solar car dimensions, motor type and rating, solar cell type and manufacturer, estimated peak solar collector power in driving configuration (overhead sun, clear sky), battery weight and estimated capacity, chassis description, braking system, and wheel type and size. All specifications must be provided in metric units (SI). The team leader, crew members, safety officer(s), designated solar car drivers, and faculty advisor(s) must also be listed. See Reg. 3.1.A for Safety Officer requirements including submission of proof of First Aid/CPR training with the Team Data Sheet.

## 4.3 Registration Deadlines

### 4.3.A Registration Dates

The registration process for the ASC is not complete until ASC Headquarters has received all documentation and the entire Entry Fee.

- 4.3.A.1 Initial registration package is due: October 15, 2019
- 4.3.A.2 Track registration package is due: December 15, 2019
- 4.3.A.3 Road registration & fee is due: March 15, 2020
- 4.3.A.4 Refund cut-off is: May 15, 2020
- 4.3.A.5 Team Data Sheet and Photo: May 1, 2020
- 4.3.A.6 Public Release of Team Data Sheets and Photos: May 15, 2020
- 4.3.A.7 Professional Engineer Signoff: June 1, 2020

### 4.3.B Late Penalties

Late fees will be imposed for fees and reports received more than ten (10) days beyond the published deadline.

- 4.3.B.1 A US\$150 fee will be imposed for late submission of the Initial Registration Package.
- 4.3.B.2 A US\$300 fee will be imposed for late submission of the Track Registration Package
- 4.3.B.3 A US\$500 fee will be imposed for late submission of the Road Registration Package.



### 4.3.C Entry Fee Payments

**4.3.C.1 Transaction Fees:** Any additional fees resulting in payments made to the Innovators Educational Foundation for entry into the Event shall be the responsibility of the team making payment utilizing such methods incurring the added fees.

**4.3.C.2 Foreign Currency:** It is the responsibility of the team for making payment in US currency. The Innovators Educational Foundation is not obliged to accept payments made in any currency other than US dollars.

**4.3.C.3 Payment Via Check:** Make checks payable to Innovators Educational Foundation and mail them to the IEF address listed on the ASC Website.

**4.3.C.4 Payment Via PayPal:** Teams can pay with a credit/debit card or bank account using PayPal. This results in transaction fees of US\$0.30 per payment plus 2.2% of the transaction (or 3.7% for payments from outside the United States). To use this method, first calculate the PayPal Transaction Amount using the following formula and then pay this amount to [ief@americansolarchallenge.org](mailto:ief@americansolarchallenge.org) in USD.

Domestic US PayPal Payment Amount = ( Entry Fee + 0.3 ) / 0.978

International PayPal Payment Amount = ( Entry Fee + 0.3 ) / 0.963

**4.3.C.5 Payment Via Wire Transfer:** A US\$50 wire transfer transaction fee shall apply to all wire transfers, which covers Innovators Educational Foundation bank fees for accepting incoming wire transfers. This fee is in addition to any transaction fees charged by the issuing bank and should be included with the payment. Contact [ascteams@americansolarchallenge.org](mailto:ascteams@americansolarchallenge.org) if your team is interested in paying via Wire Transfer.

**4.3.C.6** Payments made will be applied against the registration package in order, i.e. payment will be applied to the Initial Registration Package first, followed by the Track Registration Package etc.

## 4.4 University/College Advisor

### 4.4.A University/College Advisor

**4.4.A.1** All teams must have at least one University / College advisor ("Advisor") who will provide guidance as needed throughout the solar car design, building, and testing process.

**4.4.A.2** The University / College advisor shall be an employee of the educational institution be it a University or College etc., that is the official acting on behalf of the institution representing the participating entry into the Event.

**4.4.A.3** The Advisor will be the official contact between the Event and educational institution.

**4.4.A.4** It is strongly recommended that the Advisor attend the Event.

## 4.5 Communication between ASC Headquarters and Teams

### 4.5.A Team Members

Teams may elect a Project Manager and/or Department Managers (i.e. Mechanical Manager). Correspondence between the team and the Organizers shall be through the named individuals and the Advisor.

### 4.5.B Emails

**4.5.B.1** Participating institutions must set up a generic team email account that can be used for ASC Event correspondence and that always forwards mail to the current Project Manager, Department Manager(s), and Team Advisor. The team is responsible for ensuring that as team leaders are replaced the email forwarding is updated accordingly.

**4.5.B.2** The generic team email address must be included on all email correspondence between any team member and any Event representative.

## 4.6 Insurance

All teams need to maintain vehicular liability and general public liability insurance with limits of liability for (1) bodily injury of not less than US\$1,000,000.00 for each person and US\$1,000,000.00 for each occurrence, and for (2) property damage of not less than US\$1,000,000.00 for each accident and US\$1,000,000.00 in the aggregate. Teams will be required to provide a certificate of such insurance or proof of self-insurance.

## 4.7 Withdrawals and Exclusion

### 4.7.A Voluntary

Any team wishing to withdraw must notify ASC Headquarters in writing. All written withdrawals signed by the team representative (Faculty Advisor / Project Manager etc.) are final.

### 4.7.B Not Meeting Requirements

ASC Headquarters may withdraw teams that do not meet the technical document deadlines or fail to present a solar car that satisfies Scrutineering or Qualifier requirements.

### 4.7.C Exclusion

Exclusion will occur if the Officials deem a team to have departed from the spirit of the Event by deliberately acting to gain unfair advantage over other teams or have acted in an unsafe manner.

## 4.8 Solar Car Numbers:

Each team registered for the Event will have a unique number approved by ASC Headquarters (positive integer, three (3) digits maximum).

**4.8.A.1 Number Retention / Reservation:** Teams which have participated in four (4) or more previous ASC (Sunrayce, NASC) cross-country events have the right to reserve their car number from those openly available for selection by other teams. The number being selected for reservation must be the number used in the four (4) events.

**4.8.A.2** Requests to reserve a number shall be made in writing to ASC Headquarters, with a listing of the events which the team attended and car number.

**4.8.A.3** Car numbers (either use of a reserve number or new unallocated number) will be confirmed as team's complete registration paperwork and submit entry fees.

**4.8.A.4 Number Conflict:** If a conflict in car numbering arises, ASC Headquarters will determine the numbers assigned. Resolution will be based on order of requests and payment of entry fees with respect to when the car number request is made. If a team fails to maintain schedule of their entry fees their requested number can become available to another team who is current on their fees.

**4.8.A.5 Tracking of Reserved Numbers:** ASC Headquarters will track the Reserved Numbers, and will post a list of the Reserved Numbers and the corresponding team on the ASC website.

**4.8.A.6 Reinstatement of Reserved Numbers:** Should a team with a reserved number desire to change their number, the previously reserved number will become unallocated and available to other teams. A team cannot have more than one reserved number.

**4.8.A.7 Car #1:** The winning team from the previous ASC has the right to use the Car Number "1". This number is not available to any other team. Use of the Car Number "1" does not forfeit the retention of a Reserved number as per the regulations above and is subject to the number conflict resolution (Reg 4.8.A.4) should both past class winners desire Car Number "1" as per the regulations above.

## 4.9 Participant Registration

All participants in the Event must be registered with ASC Headquarters. This includes team members, sponsors, officials, guests, and the media. All participants must present themselves at Registration to complete all required forms. Badges will be issued and used to obtain access to restricted areas. These badges must be visible at all times.

## 5. Technical Documentation

### 5.1 Preliminary Vehicle Design Report (PVDR)

A preliminary vehicle design report must be submitted to ASC Headquarters by the date indicated in Reg. 4.3.A.1. The report shall include a preliminary design review of your vehicle's mechanical, electrical systems and proposed battery, instructions are provided in Appendix D and Appendix E.

#### 5.1.A PVDR Contents

The report shall include the preliminary design information on the structural chassis and roll cage providing protection to the driver, as well as an overview of the electrical approach to the solar car and proposed battery system. Particular attention will be given to:

- 5.1.A.1 Mechanical Team leader contact information (phone & email)
- 5.1.A.2 Roll over and impact protection for the driver
- 5.1.A.3 Electrical Team leader contact information (phone & email)
- 5.1.A.4 An overview of the electrical approach to the solar vehicle
- 5.1.A.5 A preliminary electrical diagram showing greater than 24-volt service plans.
- 5.1.A.6 Preliminary battery approval document including the battery team leader contact information (phone & email & battery manufacturer URL)
- 5.1.A.7 Battery types and suppliers/manufacturers' being considered if one is not already chosen
- 5.1.A.8 Battery testing plans with critical dates.
- 5.1.A.9 Solar Cell Approval Form.

### 5.2 Vehicle Design Report (VDR)

A vehicle design report including technical documents describing the solar car's mechanical systems, electrical systems, batteries, and solar cells must be submitted to ASC Headquarters for approval by the date indicated in Reg. 4.3.A.2. Early submissions will receive prompt review and feedback by ASC Headquarters. Early submissions may be sent as individual technical documents for review without the complete vehicle design report. The information contained in each team's final submission must match the solar car presented at Scrutineering. Safety should be the primary concern with regard to the structural development and fabrication of the solar cars.

#### 5.2.A Document Format

Vehicle design reports shall be submitted as PDF documents with a different file for each of the five (5) technical reports. PDF file names shall be formatted as: Sponsoring Organization Name\_ASC2020VDR\_Report Type. Example: a mechanical report from the University of ACME may appear as "UnivOfACME\_ASC2020VDR\_MechanicalTechnicalReport.pdf" with the first letter of each new word capitalized and common abbreviations accepted.

#### 5.2.B Mechanical Technical Report

A detailed mechanical technical report must be submitted to ASC Headquarters as part of the Vehicle Design Report by the date indicated in Reg. 4.3.A.2. The mechanical tech report must present the as-built design; addressing:

- 5.2.B.1 design issues involved in impact, roll over and suspension scenarios
- 5.2.B.2 address vehicle stability, including center of gravity and relative weights on each wheel.

Documentation with calculations and/or testing should be provided. Photos, drawings and anecdotal references are acceptable. The entire technical document including appendices shall not exceed thirty (30) pages (not sheets) in length. Detailed instructions are provided in Appendix F.

- 5.2.B.3 signed by a professionally qualified engineer

## 5.2.C Electrical System Technical Report

An electrical system technical report must be submitted to ASC Headquarters as part of the Vehicle Design Report by the date indicated in Reg. 4.3.A.2. The tech report must document the electrical design approach. The tech report must include:

**5.2.C.1** a functional system diagram; and, rough schematic; showing all essential power circuits and electrical equipment, including the Solar Array of the solar car in schematic form. The drawing should include power generation devices (array, regen, etc.), power storage (batteries, etc.), Main Power switching and isolation mechanisms, battery protection systems, motor, motor controller, Battery Fuse and any auxiliary circuits. Provide system power requirements, fuse specification sheet, high power wiring specification to support fuse & wiring selection. Anything not presented from Reg. 5.1.A.6 PVDR is also required in this report.

**5.2.C.2** Battery Approval Forms for each battery type

## 5.2.D Battery Tech Report

All storage batteries used in the solar car must be approved by ASC Headquarters. The battery tech report must be submitted to ASC Headquarters as part of the Vehicle Design Report by the date indicated in Reg. 4.3.A.2. Mass and cost will be based on manufacturer's data. If an intermediate supplier is used, submit only the cell manufacturer's data as required on the Battery Approval Form. Battery Approval Forms shall be provided on the Event website, and in Appendix H. Please note the definitions included in Reg. 8.3.A. Each team must provide a copy of the manufacturer's battery specification sheet, the Material Safety Data Sheet (MSDS) obtained from the battery manufacturer, and a battery approval form with the following battery information in the tech report:

**5.2.D.1** Manufacturer's name, and contact information and Cell Specification URL for the cell Manufacturer and MSDS.

**5.2.D.2** Stock number, type, or description

**5.2.D.3** Cell & Module voltage (e.g., 1.2, 4, 6, 12, or 24 V)

**5.2.D.4** Bus voltage

**5.2.D.5** Number of cells per module, modules per strings, strings in parallel, and total cell count

**5.2.D.6** Manufacturer's specifications, including capacity (kWh), weight (kg), and cost (US\$)

**5.2.D.7** Spill/damage protocols and procedures (if these are not provided in the MSDS then the team must obtain this information from the manufacturer and submit it to Headquarters with the MSDS)

**5.2.D.8** A description of the battery box(es) and their mounting. Include the chemical compatibility of the box material and the electrolyte in case of leakage

**5.2.D.9** Battery Approval Form for each battery type

## 5.2.E Battery Protection Tech Report:

All batteries must be protected with technology appropriate to the chemistry used. The battery protection test report must be submitted to ASC Headquarters as part of the Vehicle Design Report by the date indicated in Reg. 4.3.A.2. The tech report must document the design approach used with respect to Reg. 8.3 including the following information:

**5.2.E.1** Battery Approval Forms for each battery type

**5.2.E.2** Battery pack configuration including cells per module, modules per strings, strings in parallel, and total cell count

**5.2.E.3** Over temperature set points (charge and discharge if different) for each battery type

**5.2.E.4** Under voltage set point for each battery type

**5.2.E.5** Over voltage set point for each battery type

**5.2.E.6** Over current set point for each (charge and discharge if different) battery type

**5.2.E.7** Block diagram for BPS and component within battery enclosures for each battery type

**5.2.E.8** Description of how the BPS will operate for start-up and fault conditions for each battery type.

**5.2.E.9** How firmware or settings will be rendered static and un-modifiable after inspection (i.e. sealed in battery enclosure)

**5.2.E.10** Describe function of driver dash and BPS fault indicator strobe for External Cutoff switch, ref. Reg. 8.6.C

## 5.2.F Solar Cell Tech Report

All solar cells must be approved by ASC Headquarters. Solar cell tech reports must be submitted to ASC Headquarters as part of the Vehicle Design Report by Reg. 4.3.A.2. Solar Cell Approval Forms shall be provided on the Event website and in Appendix J and should be submitted as part of the Preliminary Vehicle Design Report by Reg. 4.3.A.1. Each team must provide a copy of the manufacturer's solar cell specification sheet, copy of invoice for all solar cells included, and a solar cell approval form with the following solar cell information in the tech report:

- 5.2.F.1 Manufacturer's name and contact information
- 5.2.F.2 Stock number, type, or description
- 5.2.F.3 Manufacturer's quote for cell area (cm<sup>2</sup>)
- 5.2.F.4 Manufacturer's quote for performance
- 5.2.F.5 Cost (US\$) per cell
- 5.2.F.6 Cell area (cm<sup>2</sup>)
- 5.2.F.7 A detailed layout map of the vehicle, showing all cell types/sizes and locations, as well as calculations of total area

## 5.3 Grading of Team Reports

Team documents will be reviewed by the Inspectors and a grade will be given to each document with the following general meanings:

- (1) Green – accepted by the Inspectors.
- (2) Yellow – partially accepted by the Inspectors. Some revision to design or additional reporting is required. An updated report is required prior to attendance at Scrutineering
- (3) Red – a late or rejected report. Significant revision to the design or significant additional reporting is required. An updated report that fully addresses Inspector comments is critical for further participation in the Event.

Grading of a team report does NOT assure passing Scrutineering as not all aspects of a design can be fully reviewed during evaluation of written reports. All solar cars are subject to a detailed technical inspection at the Event.

## 5.4 Professional Engineer Signoff

Each team must engage a professionally qualified engineer, responsible for inspecting and certifying that the solar car is designed and constructed using sound engineering practice, meets the design parameters where stated, and is roadworthy and fit for the purpose of being driven ~1800 miles on public roads. A form will be provided.

## **6. Event Components**

### **6.1 Scrutineering**

#### **6.1.A Acceptance at Scrutineering**

Only teams who have obtained Green status on their Event Registration Submissions and who have paid the required Event fees will be accepted for Scrutineering.

#### **6.1.B Participation at Scrutineering**

Each team registered for the Event must submit their entry for inspection prior to the Qualifier to verify compliance with these Regulations. In addition, spot checks for regulation compliance may take place during and immediately after the Qualifier and Tour. The top five overall finishing cars will be impounded immediately following the Tour for a final inspection at the discretion of the Inspectors.

#### **6.1.C Scrutineering Time and Location**

The date and location of Scrutineering for the Event shall be posted on the Event website. The first five teams to obtain Green status on all their Event Registration Submissions will be given preferential slots for Inspection. The order of inspection for the remaining teams will be determined by drawing. Teams that fail to present their solar car at their designated time will drop to the back of the queue and risk not having enough time to complete the Scrutineering process. Additionally, teams failing to participate in mandatory team meetings may be given last priority for Scrutineering and risk not having enough time to complete the process.

#### **6.1.D Scrutineering Format**

Scrutineering will involve inspection stations for body & sizing, driver, electrical, battery protection, array, mechanical, dynamic tests to verify handling and braking performance, and support vehicles. Instructions for Scrutineering and a detailed description of the Scrutineering tests will be distributed in advance to all registered teams.

#### **6.1.E Configuration and Drivers for Scrutineering**

All Drivers must be present for designated Scrutineering inspection stations. The driver selection and car configuration are at the discretion of the Inspectors for each station. Teams may be required to repeat tests with different drivers and/or configurations as directed by the Inspectors.

### **6.2 Qualifier**

#### **6.2.A Participation at Qualifier**

Each team must successfully participate in a Qualifier, a track rally for solar cars, before they will be allowed to compete in the Tour. The date and location of the Qualifier(s) for the Event will be posted on the Event website. Qualifying regulations are provided in Section 14.

#### **6.2.B Acceptance at Qualifier**

Only teams who have obtained Green or Blue status for each Scrutineering Inspection Station will be accepted at the Qualifier.

### **6.3 The Tour**

The Tour is a cross-country event that is open to teams who have met all Scrutineering requirements (received all greens), successfully passed the Qualification requirements and who have paid the full Event fee.

Section 12 of these Regulations outlines the format for the Tour.

## 7. Vehicle Classes

Three (3) classes of solar vehicle will be recognized as part of the Event comprising of:

- (1) Single-Occupant;
- (2) Multi-Occupant; and,
- (3) Grandfathered.

### 7.1 Vehicle Class Definitions

#### 7.1.A Single-Occupant

This class comprises solar powered vehicles designed for a single-occupant. These vehicles are akin to the “Challenger” class of vehicles from the 2019 Bridgestone World Solar Challenge.

#### 7.1.B Multi-Occupant

This class comprises solar powered and grid-charge vehicles designed for multiple-occupants. These vehicles are akin to the “Cruiser” class of vehicle from the 2019 Bridgestone World Solar Challenge.

#### 7.1.C Grandfathered

**7.1.C.1** Vehicles entered under this class are those which were entered, and passed scrutineering and qualification for ASC/FSGP 2018 or FSGP 2019 or other recognized solar car event (within a four-year period before ASC 2020).

**7.1.C.2** Vehicles in this class are not eligible for the Single-Occupant or Multi-Occupant classes as outlined above.

**7.1.C.3** Vehicles in this class will be scrutineered to the regulation set they were designed to and will be subject to additional regulations associated with safety from the Single-Occupant and Multi-Occupant class vehicle technical regulations.

**7.1.C.4** Vehicles in this class can participate as a separate class for FSGP 2020

**7.1.C.5** This class is Demonstration only for the Tour portion of ASC 2020, and will not be scored or ranked.

## **SECTION 2 – TECHNICAL**



## 8. Power

Natural solar radiation received directly by the solar collector is the only source of energy that can be used for propulsion, except for energy stored in the solar car's battery system at the beginning of the first day of racing or metered AC charging of MOVs. Energy recovered from the motion of the car on the race route may also be used.

### 8.1 Solar Collector

#### 8.1.A Cell Type

Only commercially available photovoltaic cells which fall into the following cell types may be used:

**8.1.A.1** Cell Type 1 – Silicon based solar cells.<sup>3</sup>

**8.1.A.2** Cell Type 2 – thin-film GaAs.

**8.1.A.3** Cell Type 3 – multi-junction.

#### 8.1.B Solar Collector Size Limits

**8.1.B.1** Cell Type 1 = The solar collector cannot exceed a maximum of 4.000 m<sup>2</sup> for single-occupant class solar cars, and 5.000 m<sup>2</sup> for multi-occupant class solar cars.

**8.1.B.2** Cell Type 2 = The solar collector cannot exceed a maximum of 3.560 m<sup>2</sup> for single-occupant class solar cars, and 4.440 m<sup>2</sup> for multi-occupant class solar cars.

**8.1.B.3** Cell Type 3 = The solar collector cannot exceed a maximum of 2.640 m<sup>2</sup> for single-occupant class solar cars, and 3.300 m<sup>2</sup> for multi-occupant class solar cars.

#### 8.1.C Definition of Area

Solar collectors will be measured by summing the total area of each solar cell (including all exposed bus bars, junctions and internal structure) from manufacturer's data sheets, validated through measurements.

#### 8.1.D Concentrators

If the solar collector comprises of photovoltaic cells used with concentrators such as reflectors or lenses then the total aperture of the solar collector must not exceed the allowable total area, by cell type, for non-concentrator photovoltaic solar collectors. Team wishing to use concentrator photovoltaic solar collectors must contact ASC Headquarters for more information.

#### 8.1.E Hybrid Solar Collectors

For a hybrid solar collector with multiple Cell Types as defined above the total area allowable will be based on an area ratio calculation. ASC Headquarters shall be contacted by any team pursuing this option for determination of the total allowable area.

#### 8.1.F Maximum Number of Cell Types and Sizes

Teams may use no more than six (6) types or sizes of solar cells.

#### 8.1.G Validation Documentation

At Scrutineering, teams must provide sample cells of each type and size installed on the vehicle as well as a detailed map of the vehicle array for validation per Reg. 5.2.F.

#### 8.1.H Solar Collector Connection and Stands

**8.1.H.1** All portions of the solar collector, physical attachment to the solar car, and all electrical connections between the solar collector and the solar car must be carried by the solar car. This includes but is not limited to stands, supports, and cables. This does not include hand tools that do not become part of the solar collector structure.

**8.1.H.2** Stands used for pointing the solar collector while the car is stationary must be self-supporting; stands that rely on people as a means of support will not be allowed. Teams will be required to demonstrate stands at inspection.

*Team members may temporarily steady stands in inclement weather, but it will be obvious to officials if human support of the solar collector becomes routine.*

---

<sup>3</sup> For the purposes of these regulations, the area of an uncut Sunpower cell having a width and length of 125 mm and diameter of 160 mm is 153.33 cm<sup>2</sup>.

### 8.1.I Water Spray

Ambient-temperature water from an external source may be applied to the solar collector using hand-pumped sprayers (of maximum volume of five (5) gallons) if the water is applied while the solar car is stationary and the application does not present a shock hazard.

### 8.1.J Solar Collector Reconfiguration

The solar collector can only be reconfigured for charging when the solar car is stationary.

### 8.1.K External Irradiance Amplification

External devices intended to increase the irradiance on the solar collector or increase the efficiency of the solar collector must not be used at any time. Ground sheets used when charging must not increase the irradiance on the solar collector.

## 8.2 Energy Storage

All solar cars are allowed to store solar-generated energy in an energy storage system composed of individual cells having a weight determined by the technology used.

Adherence to weight limitations does not imply automatic battery approval. Battery approval forms must be submitted to ASC Headquarters before official approval may be issued. The Inspectors reserve the right to refuse approval of modules. Unaltered samples of individual cells (minimum of three (3)) will be furnished for verification during Scrutineering.

### 8.2.A Battery Weight Limits

**8.2.A.1** Single-occupant solar cars are limited to the following amounts of commercially available battery technologies:

Li-S	15.00 kg
Li-Ion	20.00 kg
Li-Polymer	20.00 kg
LiFePo <sub>4</sub>	40.00 kg

**8.2.A.2** Multi-occupant class solar cars do not have a battery weight limit.

### 8.2.B Other Energy Storage Methods

Other energy storage technologies not mentioned (such as other battery technologies or fuel cells) will need to be evaluated by ASC Headquarters. Samples and details of proposed systems must be submitted before the date indicated in Reg. 4.3.A.2.

### 8.2.C Supplemental Batteries

**8.2.C.1** Supplemental, replaceable batteries carried in the solar car may be used to power: main power switch, radios, commercially available electronic panel meters with internal batteries, cell phones, driver ventilation fans (if solely used for driver ventilation), and the horn. Supplemental battery power may be used to momentarily power the battery protection system (BPS) as defined by Reg. 8.3 to verify safe battery parameters before energizing the main power switch. During a battery fault, in which the BPS has automatically opened the main power switch, the supplemental battery power may be used to power the battery fans per Reg. 8.4.D.

**8.2.C.2** The supplemental battery used during start-up must also be used to power the BPS, BPS Strobe, and BPS Fault Driver Indication under fault conditions. This supplemental battery must be located in the battery enclosure.

### 8.2.D Other Storage Devices

If any other energy storage devices are used (Reg. 8.2.B), they must be shown to be storing no energy and fully discharged before the start of each Tour day.

## 8.3 Protection Circuitry

All batteries must have protection circuitry appropriate for the battery technology used. Proof is required at Scrutineering that the protection system is functional and meets manufacturer's specifications. Testing procedures will be provided, and the protection system design should allow for such testing. All measurement leads should be fused or current limited to less than 1 mA for non-isolatable sinks in the measurement circuitry. All protection circuitry should be contained in the battery enclosures per Reg. 8.4.

### 8.3.A Definitions

**8.3.A.1 Cell:** The smallest available source of energy in the battery pack as purchased from a manufacturer. A single electrochemical cell.

**8.3.A.2 Module:** The smallest grouping of paralleled cells easily removable in a battery pack.

**8.3.A.3 String:** The smallest series of modules that make-up the battery pack required voltage.

**8.3.A.4 Protection Limit:** The measured level determined to be adequate to protect from an event.

**8.3.A.5 Active Protection:** System in which measurements are constantly monitored and where actions are taken immediately without operator intervention to open the Main Power Switch should a Battery Protection Fault occur. Any protection faults will latch such that a manual clearing process is required by the driver with the vehicle not in motion and only after faults have been verified clear by the protection system.

**8.3.A.6 Passive Protection:** System in which measurements are monitored by the driver and where action is driver controlled.

**8.3.A.7 Battery Protection System (BPS):** The system that applies Active Protection to protect battery pack.

### 8.3.B Types

**8.3.B.1 Li-Based:** All lithium based battery packs must have **active** protection such that over-voltage, over-temperature (for charge and discharge rating), over-current and under-voltage cause the Main Power Switch per 8.6.A to open and to electrically isolate the source or sink for the vehicle. The level of protection measurement is required down to the module level at a minimum and may be required at a cell level depending on the cell manufacturer. Fuses per Reg. 8.5 are not allowed for battery over-current protection.

**8.3.B.2 Supplemental:** All supplemental batteries must have at a minimum Passive Protection for under voltage where charging occurs remote to the solar vehicle unless they are primary cells. Active Protection is required if charging is within the solar vehicle. No Secondary Lithium battery types shall be used for the Supplemental Battery unless the Supplemental Battery is powering a commercially procured component such as a cell phone or laptop and the Supplemental Battery was intended for this purpose.

## 8.4 Battery Enclosures

All registered and sealed battery modules, battery protection circuitry per Reg. 8.3, and main fuses per Reg. 8.5 must be fully contained in enclosures that are electrically isolated from the solar car. The enclosures must be constructed from non-conductive, electrolyte-resistant material. No more than two separate such enclosures may be used. Enclosures must be designed such that they can be removed from the vehicle and placed in impound per Regs. 12.17 and 14.12.

Multi-occupant vehicles may request an exemption for the requirement to remove the batteries for impound purposes. An alternative and reliable means of securing the batteries to prevent any charging of the batteries during impound hours must be provided for vehicles requesting this exemption.

### 8.4.A Isolation

The resistance measured between the battery terminals and any portion of the solar car chassis shall be greater than 1 M $\Omega$  for applied potentials up to 500 V. Any covers allowing access into the enclosures must be firmly secured.

### 8.4.B Mounting

The battery enclosures must be secured to the solar car chassis so as to prevent them or the modules within from coming loose in the event of an accident or rollover. Nylon luggage type buckles are not acceptable means of securing the battery enclosure.

### 8.4.C Marking

The top of each battery enclosure must be marked using 10 mm high letters with "Caution: Chemical Hazard" and "High Voltage" and any other standard hazard markings specific to the type of battery enclosed. The type (i.e. Li-ion) of the battery must be marked on the top of the battery enclosures(s) in 10 mm high letters.

### 8.4.D Ventilation

Battery enclosures may be equipped with a forced ventilation system. Such ventilation systems must pull exhaust to the exterior of the solar car and must be directly connected to the exterior of the vehicle away from any airstream that may reach the driver. The ventilation system shall be powered by the battery system. In the event of a Battery Protection Fault, provisions should be made to power this fan from the Supplemental battery.

### 8.4.E External Cooling

External supplementary cooling of the battery pack is not permitted beyond the ventilation requirements listed in Reg. 8.4.D unless the external cooling is powered by the main battery pack and is physically contained and secured to the solar car, or in an emergency situation.

### 8.4.F Security

To preclude unauthorized access to the battery/enclosure, a seal will be placed to indicate contravention of this regulation. Provisions shall be made to seal the battery/enclosure by the team. Should access to a "sealed" battery/enclosure be needed, the team needs to inform their Observer of their intent to access the battery/enclosure, and request the Observer to log the activity and retain the seal. Battery exchanges will not occur during the Tour without Inspector support.

### 8.4.G Impound Box

Teams are required to provide an impound box that fully contains the battery enclosure per Reg. 8.4 and meets the following requirements.

**8.4.G.1** The box must have provisions such that an Official can secure it with a maximum of two (2) locks/seals.

**8.4.G.2** The impound box must be constructed such that it does not contain external hardware that can be removed to gain access to the battery box without breaking the seal(s).

## 8.5 Main Fuse

### 8.5.A Main

A DC-rated fuse (not a circuit breaker) must be placed first in series with the battery starting at the positive connection within each battery enclosure. Both leads to the fuse must be mechanically constrained to battery enclosure using a fuse block. The fuse rating must not exceed 200% of the maximum expected current draw or 75% of the rated wire current capacity. It must be rated to break the Fault Current due to a shorted pack and protect the relay or switch. (High Speed or Fast Acting Semiconductor Type Fuse)

### 8.5.B Branch

All other wiring size off the main bus circuit must have properly sized fuses.

### 8.5.C Voltage Taps

All battery protection circuitry (BPS) measurement leads or voltage taps off the battery must be fused or current limited to less than 1 mA for non-isolatable sinks in the Battery Protection or measurement circuitry.

## 8.6 Power Switch

### 8.6.A Main Power Switch

**8.6.A.1** Solar cars must be equipped with a main power switch that is principally located within the main battery enclosure. The power switch must be normally open and non-latching.

**8.6.A.2** The solar car driver must have overriding control and the ability to turn the power switch off at all times.

**8.6.A.3** The power switch control location must be within easy reach of the driver and clearly labeled with the words "POWER", "ON" and "OFF". All letters must be 10 mm tall or larger.

**8.6.A.4** In the off position, the power switch must isolate battery, motor and array from each other and put the solar car in the 'Safe State'. In a safe state, all high voltage conductors exiting the battery pack must be electrically disconnected from the pack.

**8.6.A.5** The power switch must be DC rated and capable of interrupting an overcurrent condition.

**8.6.A.6** The BPS must have overriding control and the ability to turn the power switch off at all times in the event of a BPS fault.

### 8.6.B BPS Fault Dash Indication

The driver is to have an illuminated dash indication of a BPS fault to provide warning of an automatic opening of the Main Power Switch.

### 8.6.C External Power Cut Off Switch

**8.6.C.1 Location:** A main power switch control location readily accessible by emergency personnel in the event of an emergency must be present on the solar car. The control location shall be on the upper surface of the solar car's exterior near the cockpit on the driver's left side. From the outside of the solar car, it must be possible to turn the main power switch off with overriding control at all times.

**8.6.C.2 Marking:** The external actuator must be clearly marked by the international marking of a red spark within a white-edged blue equilateral triangle with a minimum side length of 150 mm. In addition, clear directions how to operate the actuator must be displayed using letters 10 mm tall or larger. Non-limiting examples of such directions include 'PUSH', 'PULL' or 'OFF' with an arrow pointing in the direction of actuation.

**8.6.C.3 Covering:** The external actuator may be covered with a colorless transparent cover. Without the use of tools or significant force, it must be demonstrated that the cover is easily removable or that the actuator may be easily operated thru the cover. The cover must be labeled in such a manner as to simply direct the user how to either remove the cover or how to operate the actuator thru the cover. The blue triangle marking may be located on the cover, but must not obstruct the view of the actuator.

**8.6.C.4 Operation:** To operate the external actuator, it must require only a single simple action such as 'push', 'pull' or 'twist' etc. External actuator must also illuminate the BPS Fault indication including BPS Fault Dash Indicator.

## 8.7 Cables

### 8.7.A Cable Sizing

All electrical cables must be properly sized to expected system currents.

## 8.8 Control

### 8.8.A Sole Control

Any parameter that influences the safe and reliable operation of the vehicle must be under the sole control of the driver.

### 8.8.B Accelerator

Accelerator mechanisms on solar cars must be free moving, and when released, must return to the zero position. Should a pedal accelerator be used, it shall be mounted such that it is operated by the right foot and it shall be located to the driver's right of the brake pedal (if equipped).

### 8.8.C Cruise Control

If the solar car is equipped with cruise control, it can only be activated by the driver. The cruise control must be designed to automatically deactivate when the brake or accelerator controls are manually actuated by the driver, or when the car is shut off.

## 8.9 Electrical Shock Hazards

All exposed or easily exposed conductors, junction boxes, solar cells, etc., operating at greater than 32 V must be protected from inadvertent human contact and must be marked "High Voltage" in letters at least 10 mm high.

Exposed carbon fiber is conductive so care should be taken to ensure electrical components are isolated from it.

## 8.10 Multi-occupant Vehicle Charging and Metering

### 8.10.A Charging and Metering

MOVs must be equipped with an onboard charger. During the Event, only metered level 1 or level 2 charging is permitted using Electric Vehicle Supply Equipment (EVSE) provided or designated by the Event. The only acceptable power sources for charging are grounded 120 VAC NEMA 5-15 outlets, 240 VAC NEMA 14-50 outlets (**TBD**), or other Event designated sources. Generators with 3-wire 120 VAC or 240 VAC outlets are also acceptable sources. When charging from an external power source, the BPS must always actively monitor the battery state. In case of a BPS fault condition where the main power switches controlled by the BPS open, the output of the MOV charger must also disconnect from the battery pack. To minimize BPS faults, the onboard charger must curtail charging automatically when **the main** battery pack approaches a full charge.

### 8.10.B Charging and Safety

MOVs must include an SAE J1772 vehicle power inlet mounted and secured to the vehicle for delivering power to the onboard charger. The MOV charger must be rigidly secured in the vehicle in a location not susceptible to the ingress of water. The charger is expected to function in a manner that is compliant with the SAE J1712 standard. The output of the charger must be isolated from the AC input with at least basic insulation, but double or reinforced insulation is preferred. If the charger chassis has exposed metal, the metal must be tied to ground via the ground connection provided in the vehicle power inlet. Any AC power connections such as at the back of the inlet or at the charger must be inaccessible and enclosed with nonconductive covers that are only removable with the use of tools. Transparent covers that allow for visibility of connections are preferred. Additional measures for covering electrical connections may be required at the discretion of the Event inspectors. Note: Heat shrink tubing at least 0.4mm thick after shrunk in place is an acceptable cover for electrical connections.

### 8.10.C Charging Adapter

For MOVs designed for use in geographies with other standard connectors, an appropriate adapter may be used to go between an SAE J1772 plug and the vehicle. Vehicle charging adapters must be no longer than 1 m in length and must be carried in the MOV while not in use.

## 9. Solar Car Body

### 9.1 Solar Car Dimensions

The solar car (including solar collector) may not exceed the following maximum dimensions when moving under its own power:

Length = 5.0 m  
Height = 1.6 m  
Width = 2.2 m

When turning corners, wheels and wheel fairings may exceed these dimensions.

### 9.2 Driving Configuration

While the vehicle is moving under its own power, reorientation and reconfiguration of wheel fairings and other aerodynamic devices is allowed, however, reorientation or tilting of the solar car body is prohibited.

### 9.3 Ground Clearance

The fully-laden solar car must have a minimum ground clearance of 50 mm such that the solar car can be driven over a 50 mm object and no part of the solar car except for the tire may make contact with the object.

### 9.4 Lighting

Solar cars must have lighting as outlined below.

All lights required in this regulation be clearly visible and at least as bright as the reference standard defined in Appendix C from 30 m away throughout the required viewing angles as defined below. Inspection for the viewing angles and light intensity can be conducted at any point within the defined distance and view angles.

#### 9.4.A Daytime Running Lights / Headlamps

**9.4.A.1 Position:** must be located at the front of the vehicle at a distance at least 25% of the overall vehicle width away from the vehicle centerline and at a distance no further back than 175 mm from the absolute front of the vehicle

**9.4.A.2 Color:** white

**9.4.A.3 Viewing Angle:** 30° from center in both directions and 15° up from horizontal.

**9.4.A.4 Operations:** The Daytime Running Lights / Headlamps shall be in use when it becomes necessary to use the headlamps or windshield wipers on the team's support vehicles.

#### 9.4.B Front Turn Indicators

**9.4.B.1 Position:** must be located at the front of the vehicle at a distance at least 25% of the overall vehicle width away from the vehicle centerline and at a distance no further back than 175 mm from the absolute front of the vehicle

**9.4.B.2** Must flash between 60 and 120 pulses per minute

**9.4.B.3 Color:** amber

**9.4.B.4 Viewing Angle:** 80° from center in outwards, 45° from center in inwards and 15° up from horizontal.

#### 9.4.C Side Marker Turn Indicators

**9.4.C.1 Position:** shall be mounted on each side of the vehicle between 10% and 30% of the vehicle length rearward from the absolute front of the vehicle.

**9.4.C.2** Must flash between 60 and 120 pulses per minute

**9.4.C.3 Color:** amber

**9.4.C.4 Viewing Angle:** 60° from perpendicular to the centerline of the vehicle in both directions and 15° up from horizontal.

#### 9.4.D Rear Brake Lights

**9.4.D.1 Position:** must be located at the rear of the vehicle and at a distance at least 25% of the overall vehicle width away from the vehicle centerline and at a distance no further forward than 175 mm from the absolute rear of the vehicle.

**9.4.D.2** It is permissible to have one set of lights per side of the car which operate as both the brake lights and turn indicators. The turn indicator operation has the priority in operation.

**9.4.D.3 Color:** red

**9.4.D.4 Viewing Angle:** 80° from center in outwards, 45° from center in inwards and 15° up from horizontal.

#### 9.4.E Rear Turn Indicators

**9.4.E.1 Position:** must be located at the rear of the vehicle and at a distance at least 25% of the overall vehicle width away from the vehicle centerline and at a distance no further forward than 175 mm from the absolute rear of the vehicle.

**9.4.E.2** It is permissible to have one set of lights per side of the car which operate as both the brake lights and turn indicators. The turn indicator operation has the priority in operation.

**9.4.E.3** Must flash between 60 and 120 pulses per minute

**9.4.E.4 Color:** amber (if separately equipped from Rear Brake Lights)

**9.4.E.5 Viewing Angle:** 80° from center in outwards, 45° from center in inwards and 15° up from horizontal.

#### 9.4.F High Mounted Brake Light

**9.4.F.1 Position:** at the rear of the vehicle canopy at an elevation of not less than 700 mm above ground.

**9.4.F.2 Color:** red

**9.4.F.3 Viewing Angle:** 30° from center in both directions and 15° up from horizontal.

#### 9.4.G BPS Fault Indicator

**9.4.G.1 Position:** at the rear of the vehicle canopy at an elevation of not less than 700 mm above ground.

**9.4.G.2 Activation:** It is to activate any time the Battery Protection System (BPS) actuates to automatically open the Main Power Switch and remain active while the BPS fault is present.

**9.4.G.3** Must flash between 60 and 120 pulses per minute

**9.4.G.4 Color:** white strobe

**9.4.G.5 Viewing Angle:** 30° from center in both directions and 15° up from horizontal.

#### 9.4.H Emergency Hazard

The front turn indicators, side marker turn indicators, and rear turn indicators shall be able to be activated simultaneously and flash in sync as an Emergency Hazard format.

#### 9.4.I Horn

Solar cars must be equipped with a horn that can be heard at a sound power level between 75 and 102 dBA at a distance of 15 m in front of the solar car. The horn must be permanently mounted, operated from the steering wheel. Horn must be able to operate for up to 5 minutes continuously at the required volume.



## 9.5 Visibility

### 9.5.A Eye Height

In the normal driving position with a fully laden solar car, all occupant's eyes must be at least 700 mm above the ground.

### 9.5.B Forward and Sideward Vision

**9.5.B.1** From the normal driving position, the driver must be able to see at all times, without artificial assistance, points at the following locations:

- (1) A point on the ground 8 m in front of the solar car
- (2) A point 6.4 m above the ground and 12.2 m ahead of the leading edge of the car. (Will be inspected with a pole positioned 3 m ahead of the car)
- (3) A full 100° to either side of center

**9.5.B.2** The driver will be required to identify 75 mm high letters at a distance of 3 m from the front of the solar car, through any of the required viewing angles.

**9.5.B.3** The driver will be required to identify 50 mm high letters at a distance of 3 m from the side of the solar car, through any of the required viewing angles.

**9.5.B.4** Some elements of the roll cage may obstruct a portion of the forward vision. However, this view must be essentially unobstructed as much as is reasonably possible by the solar car structure.

### 9.5.C Windshield

**9.5.C.1** All solar cars must have a windshield made of shatter-resistant material that is securely mounted to the solar car. The windshield must be free of excessive distortion. The windshield should not be tinted to the extent that the driver cannot be clearly observed from outside the solar car.

**9.5.C.2** The solar car driver must be able to discern traffic light colors through the windshield.

### 9.5.D Rain Clearing

**9.5.D.1** Solar cars must have a method to clear the windshield from any falling rain such that the vision requirements of Reg. 9.5.B can be met.

**9.5.D.2** The clearing method must be operable at all times and must be in use when it becomes necessary to use the windshield wipers on the team's support vehicles.

**9.5.D.3** Hydrophobic coatings (such as Rain-X) are acceptable.

### 9.5.E Rear Vision

**9.5.E.1** All solar cars must be equipped with a rear-view system that at all times will allow the driver to see a vehicle 15 m directly behind the solar car and up to 30° off center. The system must provide the driver with a single reflex type image and must operate without driver input. The driver will be required to identify the direction of an arrow with a 200 mm thick brush stroke on a 1 m<sup>2</sup> board held about 1 m off the ground.

**9.5.E.2** If equipped: the camera and view screen shall be fixed in position such that road bumps and vehicle vibration will not alter the viewing angles.

**9.5.E.3** If equipped: the view screen shall be positioned such that the driver shall be able to see the view screen while seated in normal driving position.

### 9.5.F Outside Air Circulation

Outside air, from intake vents and directed towards the occupant's face, must be provided. Should intake vents from the wheel openings be used, the natural air flow rate through the ducting to the occupant compartment shall be augmented by a ventilation fan.

## 9.6 Egress

### 9.6.A Performance Requirement

**9.6.A.1** Teams shall define primary and secondary directions for egress. The primary and secondary directions must be separated by at least 90 degrees and both primary and secondary directions cannot be on the same side of the solar car. For Multi-Occupant solar cars, the primary and secondary directions may be different for each occupant.

**9.6.A.2** For Single-Occupant solar cars, teams will be required to demonstrate that the occupant can exit the vehicle unassisted, standing clear of the plane of the car, in no more than 10 seconds for the primary direction and in no more than 15 seconds for the secondary direction.

**9.6.A.3** For Multi-Occupant solar cars teams will be required to demonstrate that each occupant can exit the vehicle unassisted, standing clear of the plane of the car, in no more than 10 seconds for the occupant's primary direction and in no more than 15 seconds for the occupant's secondary direction<sup>4</sup>. It is envisioned that during the testing the drivers and occupants will be tested at the same time.

**9.6.A.4** The solar car shall not be chocked during the egress test.

### 9.6.B Occupant Cockpit and Opening

**9.6.B.1** The occupant's cockpit must be designed to allow each occupant to exit the vehicle unassisted in two directions - reference Reg. 9.6.A.1.

**9.6.B.2** Occupant egress openings must be able to be secured and released from both the inside and outside of the vehicle. Such openings may not be sealed or secured with adhesive tape at any time.

**9.6.B.3** Occupant egress openings must be positively latched – Velcro, magnets, and similar closure methods will not be allowed.

**9.6.B.4** The perimeter of the egress opening shall be clearly marked with a 25 mm wide stripe that is of a high contrast color. The external canopy release shall be marked with letters "OPEN" with a minimum height of 20 mm in the same high contrast color as the egress opening marking.

## 9.7 Ballast

Any solar car occupant weighing less than 80 kg will require ballast to bring his or her weight to 80 kg as per Reg. 11.2. Ballast weight will be measured into containers provided by ASC Headquarters.

### 9.7.A Ballast Bag

Each registered solar car occupant will be allowed one container to contain his/her required ballast. Containers will be a single colored canvas bank (coin) bag with dimensions of 305 mm x 482.5 mm. Ballast must be able to be contained within the canvas bag allowing security seals to be applied. Consideration should be made to ensure that a full ballast container will fit securely in the car's ballast carrier(s).

### 9.7.B Ballast Box

**9.7.B.1** Each solar car must have one (1) ballast box for each occupant.

**9.7.B.2** Each Ballast Box shall have a lid which is secured closed for carrying ballast. The Ballast Box(s) must be securely fastened to a structural member of the solar car and/or be demonstrated to hold the ballast fixed in the event of an impact.

**9.7.B.3** Each occupant's Ballast Box shall be located within a 300 mm horizontal distance of the occupant's hip location.

---

<sup>4</sup> It is envisioned that during scrutineering the egress of the drivers and occupants will be tested at the same time. I.e. the driver (assumed to be at the front left position of the car) will egress in their primary side, (i.e. assumed to be the left front door), whereas the passenger (assumed to be at the front right position of the car) will egress to their secondary side (i.e. assumed to also be the left front door). This is intended to check egress for a scenario where the car is against an object on the right preventing egress in that direction.

## 9.7.C Common Ballast

**9.7.C.1** Teams entered in the single-occupant class may elect to use a Common Ballast. The Common Ballast provision does not apply to drivers or passengers in MOVs.

**9.7.C.2** Should a team elect to use a Common Ballast, then each solar car driver shall have one (1) individual ballast bag and the Common Ballast bag. The sum of the two (2) ballast bags shall be equal or greater than the ballast required to bring the driver's weight up to 80 kg as per Reg. 11.2.

**9.7.C.3** Teams that plan to use a Common Ballast must equip their cars with a Common Ballast Box that complies with 9.7.B.2. This box may be located anywhere within the vehicle. The Common Ballast bag will be sealed within the Common Ballast Box at the start of the event.

## 9.7.D Ballast Access

The ballast container and its identification and security markings must be visually accessible by the observer during driver changes.

## 9.7.E Ballast Type

Teams will provide their own material for ballasting purposes. Ballast types allowed shall be either steel shot, lead shot, or coin. All other types of ballast will not be allowed. Consideration should be made with respect to the density of material selected and a driver's weight to ensure that the required ballast needed will fit into the container provided.

## 9.8 Data Logger

Solar cars may be required to carry a self-powered data logger specified by ASC Officials. The data from the logger will be used to determine vehicle location and speed. The unit weighs approximately 1 kg and has an antenna of approximately 50 mm<sup>2</sup> that requires exposure to the sky (can be through a transparent medium). Additional details will be provided by ASC Headquarters during Scrutineering.

## 9.9 Solar Car Markings

### 9.9.A Solar Car Numbers

**9.9.A.1** Each team registered for the Event will have a unique number approved by ASC Headquarters (positive integer, three (3) digits maximum).

**9.9.A.2** This number must be clearly displayed on both sides of the solar car and clearly visible from a distance of 3 m perpendicular to the side of the vehicle at a viewing height of 1.8 m above ground.

**9.9.A.3** Each number must have a minimum of 50 mm of unobstructed background color on all sides. These colors can be black on white, white on black, or another high-contrast color approved by ASC Headquarters. The numerals themselves must be a minimum of 250 mm high, 120 mm wide (except the numeral one), and have a minimum brush stroke of 40 mm. Numbers containing more than one digit must have a minimum of 25 mm spacing between the digits.

### 9.9.B Institution Name(s) & Sponsors

**9.9.B.1** The name of the Institution(s) hosting the team must be clearly displayed on both sides of the solar car and clearly visible from a distance of 3 m perpendicular to the side of the vehicle at a viewing height of 1.8 m above ground.

**9.9.B.2** ASC Headquarters must approve the use of abbreviations or initials. The Institution's name shall be larger and more prominent than any team sponsor name/logo. Additional graphics related to a team's institution(s) or sponsors are permitted, provided they are neither offensive nor disruptive.

### 9.9.C Event Logo

**9.9.C.1** The Event logo must be applied on both sides of the solar car.

**9.9.C.2** The logo will be provided by ASC Headquarters and will measure no more than 200 mm in height by 300 mm in width.

**9.9.C.3** The Event logo shall be clearly displayed on both sides of the solar car and clearly visible from a distance of 3 m perpendicular to the side of the vehicle at a viewing height of 1.8 m above ground.

### **9.9.D National Flag**

**9.9.D.1** The national flag of the country of the team must be displayed on both sides of the solar car adjacent to the windscreen and clearly visible from a distance of 3 m perpendicular to the side of the vehicle at a viewing height of 1.8 m above ground.

**9.9.D.2** The minimum size of the flag is 70 mm by 40 mm.

### **9.9.E Front Signage**

**9.9.E.1** Solar cars must have an unbroken front signage area on the solar car body at the front of the car. The required area shall be 600 mm by 150 mm when projected onto a flat panel. The entire front signage area must be visible in plain view and in front elevation view and must not overlap the solar collector. Part of the front signage area must be further forward than the solar collector.

**9.9.E.2** A 150 mm x 150 mm Event logo must be placed within the front signage area. The logo will be provided by ASC Headquarters.

**9.9.E.3** The front signage area should also include the name of the Institution(s) hosting the team.

## 10. Mechanical

### 10.1 Body Panels

All moving or removable body panels and the array must be securely fastened to prevent unintended movement.

#### 10.1.A Covers and Shields

All moving parts must be suitably covered to prevent accidental human contact when the solar car is fully assembled. The driver must be shielded from contact with all steering linkage and other moving parts.

#### 10.1.B Clearance

Interference or rubbing of the wheels with the solar car's body, wheel well, or structure at full steering lock or suspension travel is not permitted. Movement of rod-end bearings may not be obstructed in any axis throughout the full travel of suspension and steering. Other moving parts, such as the motor shaft, must not contact stationary parts except through properly designed bearings. All wheels and their suspensions, steering linkages and geometries will be inspected for safe operation in normal and adverse conditions.

#### 10.1.C Array Attachment

Teams shall provide two independent and different means of securing the solar collector.<sup>5</sup>

### 10.2 Tire and Wheel Requirements

#### 10.2.A Wheel Configuration

The solar car shall have four (4) wheels. All wheels shall be in contact with the ground at all times.

**10.2.A.1** A four (4) wheel vehicle shall be arranged such that there are two (2) front wheels and two (2) rear wheels, and the wheels within the front and rear sets are arranged symmetrically around the vehicle centerline.

**10.2.A.2** The distance between the front wheel contact patches and the distance between the rear wheel contact patches must both be not less than half the width of the solar car (at its widest point).

#### 10.2.B Design Intent

The wheels and tires must be designed for the intended application and able to withstand the loads and forces imparted by the vehicle's mass, speed capability, and braking potential. Each wheel and tire on a single axle must be rated for the full weight applied to that axle.

#### 10.2.C Tires

**10.2.C.1** Solar cars must be fitted with tires that are compliant with US DOT standards or similar equivalent.

**10.2.C.2** Tires shall be loaded and inflated within the manufacturer's rating at all times during vehicle operation.

**10.2.C.3** If the tire is deemed to be a tube-type tire as per the manufacturer's specification, the appropriate tire tubes shall be used.

**10.2.C.4** The speed rating of the tires must be more than the maximum speed of the solar car. If not, the solar car will be speed limited to the rating of the tire.

**10.2.C.5** The load rating of the tire must be more than the maximum static load imposed by the fully-laden solar car.

**10.2.C.6** The tires must be free of any apparent defect.

#### 10.2.D Wheels/Rims

The rim profile must be shown that it is in accordance with (or matches) the bead requirements of the tire as specified by the tire manufacturer.

---

<sup>5</sup> The two independent and different methods requirement is meant to provide additional reliability. The two methods could be for example 1) perimeter locking and 2) back-up lanyard.

## 10.3 Cockpit

The cockpit may not subject the solar car occupants to excessive strain during normal operation, and must be designed to protect the occupants from injury in the event of an accident. The occupants must be provided adequate space for safe operation of the vehicle. Care needs to be taken in the design and construction of the vehicle to minimize the risk that any shafts or sharp objects could penetrate the cockpit in the event of a crash and potentially injure the occupants.

### 10.3.A Occupant Cell

**10.3.A.1 Roll Cage:** is the structural cage that encompasses the occupants from the level of the shoulders upward.

**10.3.A.2 Structural Chassis:** is the tubular frame / monocoque composite chassis / hybrid of composite & tubular frame which encompasses the occupant's bodies, and to which the vehicle suspension system is connected.

**10.3.A.3** All solar cars must be equipped with a roll cage that is fixed and integrally connected to the structural chassis.

**10.3.A.4** The roll cage shall be constructed with metal elements. Composite roll cages are not permitted.

**10.3.A.5** The combination of the solar car structural chassis and roll cage comprises the Occupant Cell.

**10.3.A.6** Teams must provide documentation that specifies which parts of their solar car constitute the Occupant Cell.

**10.3.A.7** The Occupant Cell shall encompass the occupant in all directions. When occupants are seated normally, with safety-belts and helmets on, no part of any occupant, nor the full free range of motion of the occupant's head (including helmet), may intersect with the convex hull of the occupant cell.

*Imagine stretching a rubber skin around the occupant cell; no part of any occupant or their helmet may touch the skin.*

**10.3.A.8** Each team must provide calculations, certified by the team's certifying engineer, to show that the occupant cell will not deform by more than 25 mm and will not fail at any point when subjected to the following load cases, where g is the total gross mass of the vehicle including all occupants and ballast as outlined in Appendix E:

- Frontal impact: a 5 g load, opposing the direction of travel, applied to the front of the occupant cell in an area less than 250 mm high and less than 600 mm wide
- Side impact: a 5 g load into the side of the safety cell, applied adjacent to the driver's torso in an area less than 250 mm high and less than 600 mm wide
- Top impact: loads of 5 g down, 1.5 g sideways and 4 g backwards, applied simultaneously at each area of contact between the occupant cell and the ground when the occupant cell is upside down; the contact area for each test load must have a diameter less than 150 mm.

**10.3.A.9** The protection provided for the occupants in a collision must be documented in the team's Mechanical Technical Report as per Reg. 5.2.B.

**10.3.A.10** A preliminary sketch and description of the Occupant Cell must be submitted to ASC Headquarters by the date indicated in Reg. 4.3.A.1, as per Reg. 5.1.A.

**10.3.A.11** In addition to providing collision and rollover protection, the roll cage must be designed so as to deflect body/array panels of the car up and away from the occupants in the event of an accident. The front roll cage shall be angled backwards to facilitate deflection of the body/array panel.

**10.3.A.12** Wherever the Occupant Cell may come in contact with an occupant's helmet, the roll cage or structure must be padded with energy-absorbing material meeting SFI-45.1 or FIA 8857-2001 Type A or B, or better. This material must be bonded and secured to the structure, wrapping around 50% of the roll cage member or piece of vehicle structure. In addition, a headrest of at least 20 mm thick resilient material must be securely mounted behind the occupant's head without the use of cable ties, fabric straps, or temporary attachments. The headrest must support the occupant's head in normal driving position.

**10.3.A.13** There must be 50 mm of clearance in all directions between any member of the Occupant Cell and the helmets of the occupants seated in the normal driving position. There must be at least 30 mm of clearance between the occupant's helmet and the padding to allow for free movement of the occupant's head.

### 10.3.B Occupant Seats

**10.3.B.1** Single-occupant solar cars shall only have one seat.

**10.3.B.2** Multi-occupant solar cars shall be designed to carry more than one occupant.

**10.3.B.3** Each solar car occupant must have a seat that faces forward at an angle less than 10 degrees from the forward direction of travel.

**10.3.B.4** Each seat must have a back and a head restraint Reg. **Error! Reference source not found..** The distance from the hip point to the top of the head restraint must be at least 800 mm for front seats and those of a single-occupant solar car and at least 750 mm for rear seats. (49 CFR 571.202a - Standard No. 202a; Head restraints). The hip point may be approximated as shown in the diagram below. Any additional seat padding must be included in this measurement.



**Figure 10.1 – Hip Point Definition**

**10.3.B.5** Each occupant's heels must be below their hip point.

**10.3.B.6** The angle between each occupant's shoulders, hips and knees must be more than 90 degrees.

**10.3.B.7** Any additional seat padding must be positively secured to the seat.

### 10.3.C Occupant Space

**10.3.C.1** The occupant space for each occupant's upper torso shall be defined by an arc defined with an 835 mm radius measured from the hip point as defined in Appendix B of the occupant and projects forward 45 degrees from vertical, 25 degrees rearwards and 7 degrees side-to-side from the centerline of the occupant<sup>6</sup>.

**10.3.C.2** The solar car structure, including the windshield must lie wholly outside the occupant space. The steering wheel, mirrors, seat backs, and head restraints may be inside the occupant space but must be designed to minimize the risk of injury to the occupant.

**10.3.C.3** The driver's head must be above and behind the driver's feet. The seat must be appropriately constructed with a solid base and back rest.

### 10.3.D Belly Pan

The cockpit must be equipped with a full belly pan to isolate the occupants from the road. The belly pan must be strong enough to support the full weight of each occupant. Each occupant's torso and limbs must be above the lower element of the structural chassis.

### 10.3.E Safety Belts

**10.3.E.1** All solar cars must be equipped with a minimum of a 5-point lap and shoulder belt harness system for each occupant.

**10.3.E.2** The use of safety belts is mandatory.

**10.3.E.3** The safety belts must be installed and attached securely to the structural chassis, as recommended by the manufacturer.

**10.3.E.4** The placement of the attachment points for the seat belt harness shall be as follows (unless

<sup>6</sup> This minimum occupant space requirement is based on a 50-percentile male and does not allow for a helmet. Taller team members may need more occupant space.

otherwise specified by the manufacturer):

**10.3.E.5** The shoulder straps attachment point shall be rearwards between horizontal and highest of 30 degrees below horizontal and perpendicular to the occupant's spine or seat back

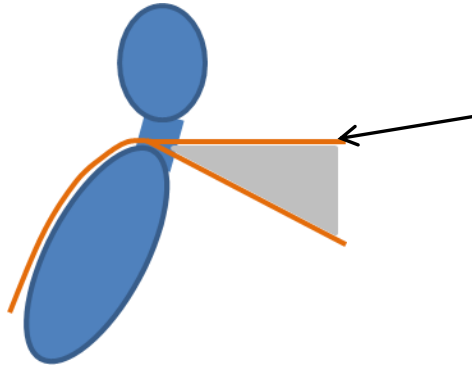

**Figure 10.2 Range of shoulder strap attachment position**

**10.3.E.6** The shoulder belts shall be spaced wide enough apart to not squeeze on the neck, but narrowly enough that they will not fall off the shoulders. The mounting points shall extend backward and go inward by approximately one unit for every two units that the mounting point is located behind the point that the belt leaves the shoulder.

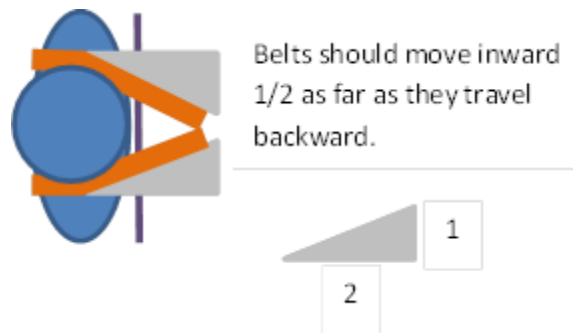

**Figure 10.3 Horizontal configuration of shoulder strap attachment**

**10.3.E.7** The lap belt attachment point shall be downwards and rearwards from the occupant's lap between 60 degrees and 80 degrees from horizontal. The ends of the belt need to be well below the lap of the driver.

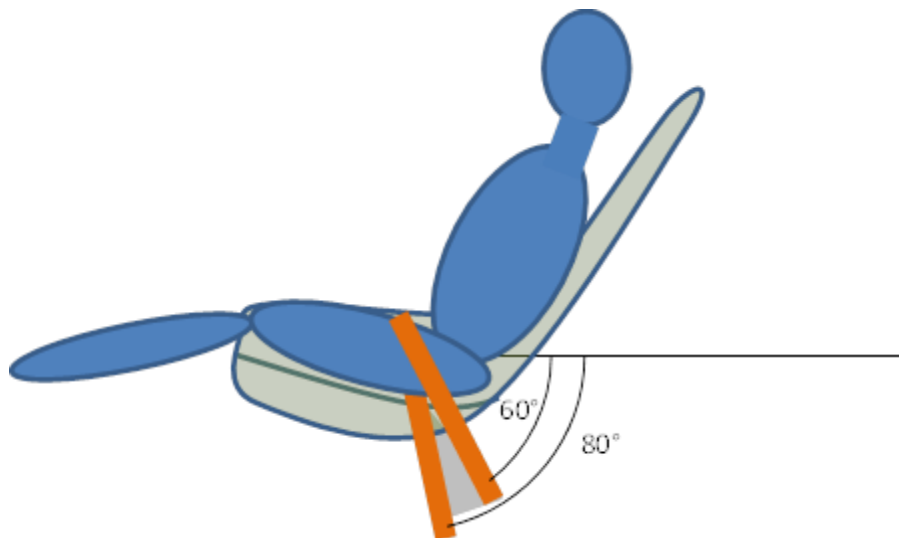

**Figure 10.4 Configuration of lap belt attachment**



**10.3.E.8** The anti-submarine belt attachment shall be approximately 10 degrees forward of plane of shoulder belts for 5-point or approximately 20 degrees rearward of plane of shoulder belts for 6-point belts.

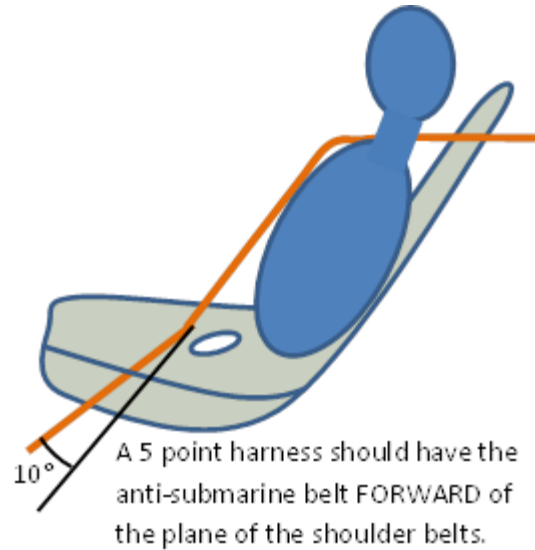

**Figure 10.5a Configuration of anti-submarine belt attachment (5-point harness)**

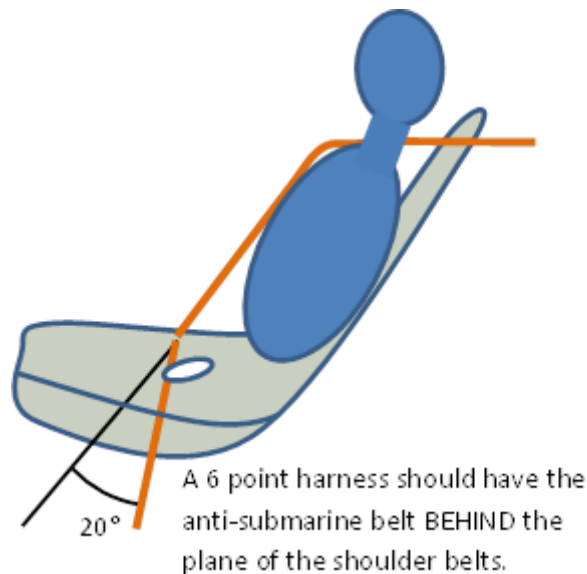

**Figure 10.5b Configuration of anti-submarine belt attachment (6-point harness)**

**10.3.E.9** If the belt passes through the seat, it must pass through without wrinkling, crimping or bending the belt excessively. All sharp edges shall be removed or covered to prevent cutting or fraying of the belt.

**10.3.E.10** Only safety belt systems manufactured and certified to FIA 8853/98, FIA 8853-2016, SFI 16.1 or SFI 16.5 are allowed. Any modifications must be approved by the manufacturer.

## 10.4 Fasteners<sup>7</sup>

All fasteners must be of suitable type, strength, and durability for their application. Friction or press fit assemblies will not be accepted in critical areas as the sole means of retention. Set screws intended to transmit torque or force will not be accepted. Fasteners must meet the following minimum requirements:

### 10.4.A Bolts

Bolts used in critical areas must at minimum meet SAE grade 5, metric grade M8.8 and/or AN/MS specifications. Bolts must be of the correct length, and extend at least two threads beyond the nut. Bolts in tension must not have shaved or cut heads. All fasteners should be properly torqued.

### 10.4.B Securing of Fasteners

All structural and other critical fasteners (bolts, nuts) must have an acceptable form of securing such that the fastener cannot loosen or be removed unintentionally. Acceptable methods of securing are:

- (1) Bolts with flex-loc type nuts or other nuts that use flexure as the means of locking and are re-useable.
- (2) Bolts with pre-drilled shafts and castle nuts with cotter pins installed to prevent loosening
- (3) Bolts with pre-drilled heads and/or nuts properly safety wired with stainless steel wire from 0.024" (0.6 mm) to 0.032" (0.8 mm) diameter conforming to Mil Spec MS20995C. The safety wire between fasteners and anchor points must be twisted to prevent loosening rotation of the fastener.
- (4) In blind hole applications, bolts with pre-drilled heads properly safety wired.
- (5) Other methods of securing fasteners may be deemed acceptable at the discretion of the Inspector.

Securing methods that are not acceptable are Nylon lock nuts, "lock" washers, Loctite, or lock nuts that use thread distortion as a means to secure the nut. Lock nuts with thread distortion are not considered to be re-usable. Other methods of securing fasteners where the above methods are not appropriate may be considered at the discretion of the Inspector. Non-critical fasteners need not be secured with lock nuts.

### 10.4.C Securing Rod Ends

All rod ends shall be secured with jam nuts tightened with sufficient torque to prevent the rotation. The jam nuts on rod ends do not need to be safety wired or do not need to be flex-loc type of nut.

### 10.4.D Buckles and Straps

Plastic luggage type buckles or single push release straps are not considered acceptable means of securing any Critical Area. If nylon type straps are used in securing any Critical Area, ratchet type straps (without hook terminators) shall be used.

### 10.4.E Critical Areas

For application of the above critical areas are defined to include: steering, braking, suspension, seat mounts, safety harness, drive train, battery box, and ballast carrier.

---

<sup>7</sup> Fasteners are a complex subject and much care should be taken to choose appropriate fasteners for each application. Excellent references on proper use and securing of bolts can be found:

Smith, Carrol. Prepare to Win.

Reithmaier, Larry. Standard Aircraft Handbook.

Federal Aviation Administration. FAA Advisory Circular AC43-13-1B. Chapter 7.

## 10.5 Brakes<sup>8</sup>

### 10.5.A Configuration

Solar cars must have a dual, balanced braking system so that if one system should fail, the solar car can still be stopped. The two systems must be operationally independent and must operate from a single foot pedal. The braking system can be front/rear or redundant front. Left/right redundancy is not permitted. Hydraulic systems must have separate master cylinders. Regenerative brakes may not be considered as one of the braking systems.

### 10.5.B Brake Pads

Each brake pad used in the braking systems must have a contact area with the brake disk that is greater than 6.0 cm<sup>2</sup>, and the pad must have full contact with the brake rotor. Pads must initially be at least 6 mm thick including the backing plate when installed on the car.

### 10.5.C Braking Performance

Solar cars must be able to repeatedly stop from speeds of 50 km/h or greater, with an average deceleration, on level wetted pavement, exceeding 4.72 m/s<sup>2</sup>. Performance shall be demonstrated with mechanical braking only.

### 10.5.D Brake Lines/Cables

The brake lines (hydraulic or cable) shall be appropriately sized and constructed such that they have significant capacity beyond the pressure and/or loads that will occur under the worst-case driving conditions.

### 10.5.E Clearance between Pedals

If the team elects to have foot operated brake and accelerator pedals the team must demonstrate adequate clearance and arrangement that will allow for quick and easy transition of the foot from one pedal to the other. Refer to Reg. 8.8.B for placement of the accelerator pedal if equipped.

### 10.5.F Hand Activated Brakes

Hand activated brakes are permissible if the driver can turn the steering wheel lock-to-lock without removing or repositioning either hand from the steering wheel.

### 10.5.G Cars with Mechanical Rear Brake

**10.5.G.1** For solar cars without anti-lock brakes, the front wheels must lock-up before the rear wheels.

**10.5.G.2 Performance:** Cars with mechanical rear brakes as one of their primary brake systems shall be able to demonstrate that the rear brake can hold the car in place (front wheels elevated off the ground) on dry pavement under a forward pull equal to 15% of the cars weight in Tour configuration with properly ballasted driver in place.

**10.5.G.3 Volume Limiting Valve-System:** cars with mechanical rear brakes with proportioning valves will require a means to lock-out the proportioning valve setting. The proportioning valve shall be positioned out of any occupant's reach.

## 10.6 Parking Brake

Solar cars must be equipped with a parking brake.

### 10.6.A Performance

The parking brake shall be able to hold the car in place without wheel chocks on dry pavement under either a forward or rearward force equal to 10% of the cars weight in fully loaded condition.

---

<sup>8</sup> Braking systems for solar cars should be designed in accordance with standard automotive engineering practice. In general, bicycle type brakes are deemed to be too fragile for this kind of application and will not pass scrutineering. This includes mountain bike type disc brakes. While such brakes may have enough stopping power to slow down a solar car, over long periods of application descending hills common in the ASC routes, they do not have appropriate levels of brake energy dissipation. Larger pads with more contact area can help ensure that vehicle braking systems are designed to dissipate heat to prevent failures involving boiling brake fluid, disc warpage, and loss of braking force. Vehicles that do not heed these recommendations may not pass scrutineering or be allowed to compete.

### **10.6.B Independence**

This brake must operate completely independently from the main braking system and may not be used in the performance tests specified in Reg.10.9.D.

### **10.6.C Locking**

It must be able to be locked into the "ON" position, such that the driver does not have to continue to hold it to maintain position. The driver shall be able to lock the parking brake while seated in the normal driving position and seat belted in.

### **10.6.D Contact Style**

The parking brake shall not be of a tire or wheel contact style (i.e. pad on tire or pad on rim styles are not considered as acceptable designs).

## **10.7 Steering**

### **10.7.A Steering Wheel**

All steering in the vehicle must be controlled by the driver with a steering wheel designed to have a continuous perimeter as outlined in Appendix A.

### **10.7.B Steering Stops**

The steering system must include steering stops to prevent dangerous or damaging steering travel. Steering stops cannot be held in place by friction. They must be welded, pinned or bolted in place, and placed in the steering system in way that will not create loads that will deform or scar the contacting pieces.

### **10.7.C Turning Radius**

Solar cars must be able to make a U-turn in either direction, without backing up, such that any portion of the solar car that is within 200 mm of the ground remain within a 16 m wide lane. Portions of the solar car above 200 mm above ground may exceed the 16 m distance.

### **10.7.D Steering Backlash**

The steering system must be designed with sufficient strength/stiffness and have minimal backlash so that the driver can always maintain good directional control of the vehicle.

## **10.8 Towing Hardpoint**

Solar cars must be equipped with a hardpoint where an appropriate rope or strap may be attached in order to tow the car for emergency recovery purposes. The hardpoint must be either securely attached to or part of a non-moving structural component such that the car can be towed in the forward direction. The hardpoint or access to the hardpoint may be covered while not in use. The hardpoint must allow the car to be pulled with the body installed on the car; however, the canopy may be removed.

## 10.9 Dynamic Stability

Solar cars will be tested for dynamic stability and handling performance. A combination of the following tests may be conducted:

### 10.9.A Figure-8

Solar cars must be able to negotiate a Figure-8 course in less than 9 seconds per side. The Figure-8 course shall have a 5 m wide lane around two (2) 6 m radius center circles, as illustrated in Figure 7-2. The vehicle shall not knock over any of the cones or exhibit signs of structural instability. No body work shall contact moving structural members per Reg. 10.1.B.

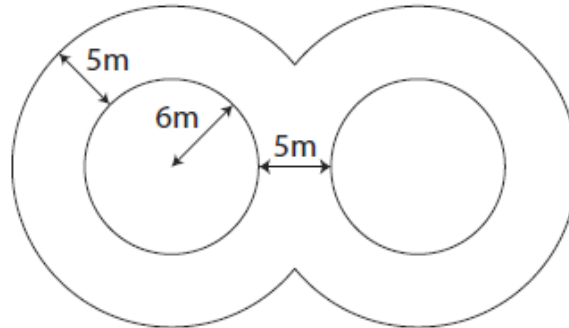

Figure 7-2 Figure-8 Course Layout

### 10.9.B Stability at Speed

Solar cars must be able to stay within a 3.5 m lane for at least 250 m. Cars must be able to achieve this regardless of crosswinds or gusting conditions. If a car cannot do this at 104.6 km/h (65 mph), the car speed will be limited to where it can stay within a 3.5 m lane for the entire Event.

### 10.9.C Slalom Test

Solar cars must be able to negotiate a slalom course in 11.5 seconds. The slalom course shall be 126 m long, with cones equally spaced every 18 m as in Figure 7-3.

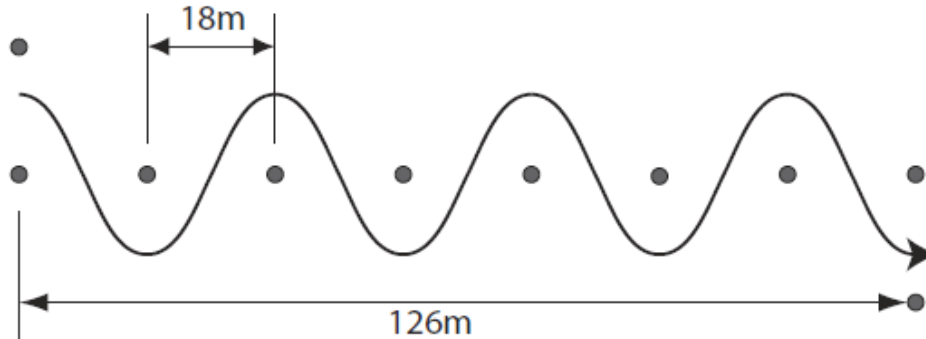

Figure 7-3 Slalom Course Layout

### 10.9.D Brake Test

Solar cars will be tested to verify compliance with Reg. 10.5.C (Braking Performance). The time interval over which the deceleration is averaged shall be from the first indication that the driver should stop until the solar car comes to a complete halt. When braking, the solar car must not veer excessively to the left or right, or exhibit structural instability. The tire pressure and mechanical systems settings used in this test will be considered as the driving configuration.

**10.9.D.1** Solar cars may be required to demonstrate the brake performance a minimum of two (2) out of three (3) times.

### 10.9.E Disqualification of a Driver

Should it become apparent to the ASC Officials that the solar car is capable of passing the required dynamic stability requirements, but driver is not able to proficiently handle the solar car during one or more of the required components, the solar car driver may be disqualified at the discretion of the ASC Officials.

# 11. Occupant Requirements

## 11.1 Occupant Registration

All solar occupants (drivers and passengers) must be registered at scrutineering. All occupants must be 18 years old or older.

### 11.1.A Drivers

**11.1.A.1** Only registered solar car drivers will be allowed to drive solar cars during the Event.

**11.1.A.2** Each team shall have a minimum of two (2) drivers available at all times and may register at most four (4) drivers.

**11.1.A.3** All drivers are required to submit an informational form and a copy of their driver's license before Scrutineering.

**11.1.A.4** The solar car driver must be in the solar car during operation of the car.

### 11.1.B Passengers

**11.1.B.1** Drivers are eligible as solar car passengers. Teams may register at most eight (8) additional solar car passengers.

**11.1.B.2** The maximum number of occupants in a multi-occupant solar car shall be equal to the number of seats and seat belts provided.

## 11.2 Occupant Weight and Ballast

### 11.2.A Occupant Weight

The official weight of each occupant, including clothes (including shoes, excluding helmet, with empty pockets), will be 80 kg. If an occupant weighs less than 80 kg, ballast will be added to make up the difference. If an occupant weighs more than 80 kg, no credit will be given.

### 11.2.B Occupant Ballast

Occupants and their corresponding ballast will be identified with unique identification tags. The tags on the ballast carried by the solar car must match the tags on the occupant at all times. Occupants must supply their own ballast material.

## 11.3 Helmets

All solar car occupants must wear a helmet while operating the solar car. The helmet must meet or exceed the Snell 2010 or Snell 2015, DOT, or ISO motorcycle standards and will be inspected during Scrutineering.

## 11.4 Shoes

All solar car occupants must wear closed-toe shoes with a solid sole that will protect the occupant from debris that may be found on the road in the event of an accident in the solar car. Shoes with individually enclosed toes will not be permitted. Shoes that are securely fastened to an occupant's foot are preferred to avoid unintentional removal when driving or egressing the solar car. Occupant's shoes shall be approved at the Inspectors discretion.

## 11.5 Duration in Car

Each occupant may not be in the solar car more than a cumulative total of six (6) hours in a given Qualifier or Tour Day. If the solar car is stopped on the side of the road such that the occupant is allowed to exit the vehicle for an extended period of time, this stopped time is not counted towards the six (6) hours driving time.

*This applies regardless of role in the solar car. For instance, if an occupant drives the solar car for five (5) hours in a day, they may only remain in the solar car as a passenger for one (1) additional hour during that day.*

## 11.6 Water/Fluids

Each occupant must have sufficient quantities of water/fluids in the cockpit area to stay properly hydrated. A minimum of one liter for each occupant must be provided.

## **11.7 Driver Communication**

### **11.7.A Driver Communications**

All communications by the solar car driver must be verbal and hands-free at all times. Hands-free operation is defined as operation where the driver can activate the radio without removing his/her hands from the steering wheel.

### **11.7.B Cell Phone Use**

Cell phones are permitted within the solar car. Any use of a cell phone in the car will need to be on a hands-free basis. Use of cell phone must comply with all local laws pertaining to cell phone use within a vehicle. Any cell phone must be fixed in position (i.e. not loose within the driver compartment).

### **11.7.C Solar Vehicle Driver Communication**

For both single and multi-occupant vehicles, the driver of the solar car must be in communication with the solar car caravan.

## **SECTION 3 – OPERATIONS**



## 12. Tour

### 12.1 Format

The Tour is comprised of a series of stages between predetermined locations (Stage Points) following a specific Tour Route. Each stage will begin with a Staged Start, where all solar cars are released from the same point. At the end of any driving day during which an entry has not reached the next planned Stage Point (and does not trailer to that Stage Point), the team will stop where they are located along the Tour Route. The team will begin the next morning at the same point, following regulations established for Non-Staged Starts. Stages may also have mandatory Checkpoints and optional loops that may be completed to increase distance.

### 12.2 Determination of Winner

#### 12.2.A Single-Occupant Vehicles

The team with the most Official Total Distance driven on solar power will be declared the winner of the Tour. Subsequent placings will be based on the ranking of Official Total Distance. Should teams tie on Official Total Distance, Official Total Elapsed Time will be used as a tie-breaker to determine ranking placements.

#### 12.2.B Multi-Occupant Vehicles

Refer to Regulation 13.

### 12.3 Solar Car Configuration

Solar cars must drive in the same configuration as approved during Scrutineering and used at the Qualifier.

### 12.4 Support Vehicles

All vehicles and trailers associated with a team other than the solar car itself are support vehicles and must be registered with ASC Headquarters. All vehicles must meet US/Canada Federal Motor Vehicle Safety Standards.

#### 12.4.A Drivers

A minimum of two (2) drivers should be available for each vehicle associated with the team.

#### 12.4.B Lead Vehicle

Each team must provide a "lead vehicle" to alert oncoming traffic to the presence of the solar car.

**12.4.B.1** The lead vehicle must travel within 500 m ahead of the solar car, with its headlights on and with roof-mounted flashing amber lights visible from ahead (single bulb rotating beacon lights are not considered to be acceptable).

**12.4.B.2** The lead vehicle may not tow a trailer.

**12.4.B.3** The lead vehicle shall not be larger in height or length than a standard 15-passenger, full-size van.

**12.4.B.4** The lead vehicle shall carry at a minimum the following safety equipment: certified, stocked first aid kit, ABC fire extinguisher (4.5 kg or larger), safety vest (1 per occupant), four (4) orange cones (minimum 300 mm high), and an orange warning flag.

#### 12.4.C Chase Vehicle

Each team must provide a "chase vehicle" to protect the solar car from the rear.

**12.4.C.1** The chase vehicle must follow directly behind the solar car; with roof-mounted, flashing amber lights visible from the front and the rear (single bulb rotating beacon lights are not considered to be acceptable).

**12.4.C.2** The chase vehicle may not tow a trailer.

**12.4.C.3** The chase vehicle shall be equipped with a commercially available/unmodified GPS unit that displays the current vehicle speed visible to the Observer.

**12.4.C.4** The chase vehicle shall not be larger in height or length than a standard 15-passenger, full-size van.

**12.4.C.5** The chase vehicle shall carry at a minimum the following safety equipment: certified, stocked first aid kit, ABC fire extinguisher (10 kg or larger), safety vest (1 per occupant), four (4) orange cones (minimum 300 mm high), orange warning flag, battery MSDS, battery spill kit and method of containment of battery fires / 40 kg of sand.

### **12.4.D Scout Vehicle**

Each team is permitted to include a “scout vehicle” in their convoy for the purpose of investigating road and traffic conditions ahead of the solar car.

**12.4.D.1** The scout vehicle should maintain at least a 1 km separation from the solar car caravan and all other solar car caravans.

**12.4.D.2** The scout vehicle must not obstruct traffic or other solar car convoys.

**12.4.D.3** The scout vehicle shall not be larger in height or length than a standard 15-passenger, full-size van.

### **12.4.E Other Support Vehicles**

Additional support vehicles, including truck/trailer units, may travel on the Tour Route, but should maintain at least a 1 km separation from all solar car caravans. These other support vehicles must not obstruct traffic or other solar car caravans.

### **12.4.F Support Vehicle Graphics**

All support vehicles, including trailers, must be marked with:

**12.4.F.1** The team’s solar car number (at least 250 mm tall, with a 40 mm brush stroke) on both sides and the rear.

**12.4.F.2** The name of the team’s sponsoring Institution(s) must also be displayed prominently on both sides of each vehicle.

**12.4.F.3** The scout, lead, and chase vehicles must also display the team’s solar car number on the top passenger side of the front windshield (at least 15 cm tall).

**12.4.F.4 Event Logo:** ASC Headquarters will provide two (2) Event Logos per support vehicle to be placed on the sides of each vehicle and trailer. These logos will not be larger than 310 mm in height by 460 mm in width.

**12.4.F.5 Slow Moving Caravan:** A sign must appear on the rear of the chase vehicle to warn overtaking traffic of the solar car caravan. Signs will be provided by ASC Headquarters at a size of no larger than 500 mm by 500 mm. Teams desiring to create their own signs may do so provided “CAUTION: SOLAR CAR CARAVAN AHEAD” is the wording used and is clearly indicated on a contrasting background. Alternative signage must be pre-approved before arrival at Scrutineering by the Inspectors.

**12.4.F.6** Additional graphics are permitted, provided they are neither offensive nor disruptive.

## **12.5 Radios / Communication**

The chase vehicle must be in two-way radio communication with the solar car driver at all times. All two-way radio channels must be registered with ASC Headquarters. All teams must also have a separately monitored CB radio in every support vehicle on the route tuned to an “official event” CB channel to communicate with other nearby teams and officials.

### **12.5.A Observer Monitoring**

All communications between the solar car driver and support vehicles must be audible (for voice communications), to the observer at all times. Any communications in languages other than English, in code, must be explained to the observer if requested.

### **12.5.B Driver Communications**

All communications by any driver must be verbal and hands-free at all times. Hands-free operation is defined as operation where the driver can activate the radio without removing his/her hands from the steering wheel.

## 12.6 Observers

Trained Observers selected and sponsored by ASC Headquarters, will travel with each team to alert the Inspectors to possible infractions of these Regulations, and to help report unforeseen events to ASC Headquarters. Observers may not interpret these Regulations or give advice on Tour strategy. Observers will be rotated in their team assignments at Checkpoints and Stage Locations.

### 12.6.A Observer Access for Inspection

Observers will be assigned to keep each solar car in sight from the time the batteries are released from impound to the time they are impounded again each day. The Observers shall witness and note any and all work done on the solar cars. The Observers must be allowed access to the solar cars for inspection of ballast during all driver changes.

### 12.6.B Observer Record of Performance

The details of the activities of a team will be recorded in a logbook carried by the Observer. The team leader and advisor will be permitted to review the book each day; however, failure to do so does not make any record invalid. The records kept by the Observer include the Official Start Time, stopping times (including Checkpoints and stage finishes), impound times, distances traveled, and any apparent rule infractions either by their assigned team or by any other team.

### 12.6.C Observer Accommodations

**12.6.C.1 During Tour Hours:** Teams must allow the Observer the seat of his or her choice behind the driver in the chase vehicle. The Observer must be able to see the solar car and read the chase vehicle's speed via a commercially available/unmodified GPS unit from this location. The Observer must also be able to determine, at least periodically, how many vehicles are following behind the team.

**12.6.C.2 Before and After Tour Hours:** Teams must provide a secure shelter for the observer of the quality of the best provided accommodations to any team member or advisor. Teams must also provide a secure location approved by the observer for the battery impound box.

**12.6.C.3 Meals and Lodging:** Observers should be considered a guest of the team for whom the team will supply proper meals, drink, shelter, and amenities afforded to any member of the team or advisor.

## 12.7 Team Uniforms

For the duration of the Event, team members shall wear uniforms representing their Institution(s) from 7:00 am to 8:00 pm. The uniforms are required to have the Institution name, car number, and ASC logo. If team sponsors are displayed, the Event sponsor(s) must also appear in a similar manner on the team uniform. Artwork for the ASC logo and for the Event sponsor(s) may be obtained from ASC Headquarters.

### 12.7.A Solar Car Occupants Attire

Solar Car Occupants, while within the solar car, are exempted from the above requirement. Clothing worn by solar car occupants must provide suitable cover and be non-offensive.

## 12.8 Briefings

A Briefing will be held at each Stage Start location. A special meeting may be called in cases of emergency. Attendance at meetings by a team representative and driver(s) is required. Briefing notes and other daily updates will be available at Checkpoints and posted to the Event website. All official statements, rule interpretations, and special instructions will be contained in these postings. On Non-Staged Days it will be the responsibility of the team to check available outlets for updates and instructions.

## 12.9 Timing

### 12.9.A Responsibility

Timing and distance determinations for the Event will be the responsibility of ASC Timing Officials. ASC Headquarters will recognize no other timing or distance information.

### 12.9.B Official Elapsed Time and Official Distance

**12.9.B.1** Two metrics will be used for determination of placing for the event. Teams will be ranked first by distance and second by time to complete that distance.

**12.9.B.2** An Official Elapsed Segment Time and Official Segment Distance will be calculated for each entry based on the actual Tour Time that has elapsed and Tour Distance driven between each stage/checkpoint to the next stage/checkpoint. The summation of these Segment Times and Segment Distance will yield an Official Total Elapsed Time and Official Distance for the entry.

**12.9.B.3** Overall placing will be determined based on the highest Official Total Distance driven. (Reg. 12.2).

**12.9.B.4** For teams that tie on Official Total Distance, placement will be determined by the lowest Official Total Elapsed Time.

### 12.9.C Official Elapsed Segment Time and Segment Distance

Official Elapsed Segment Time and Segment Distance will be the entry's elapsed Tour Time and Tour Distance from one stage/checkpoint to the next stage/checkpoint, plus any penalties and any protest filing fees. Note that protest filing fees are counted against the interval on which the protest is filed, whereas penalties are counted against the interval in which the infraction occurred. Thus, the Official Elapsed Segment Time and Tour Distance are not final until after the end of the Tour.

*Official Elapsed Segment Time = Elapsed Tour Time + Penalties + Protest Filing Fees*

*Official Elapsed Segment Distance = Elapsed Tour Distance – Penalties – Protest Filing Fees*

Note for the distance based metric, penalties and protest filing fees are subtracted from the distance in order to reduce to the distance covered.

### 12.9.D Team Off-Course

If a team departs from the Tour Route, but then returns properly to the route and continues, their Elapsed Segment Time will be determined in the normal manner; no credit will be given for the time the team was off-course.

## 12.10 Tour Hours

### 12.10.A Standard Tour Day

The Standard Tour Day is from 9:00 am – 6:00 pm (9 hours) for all days of the Tour. Actual Tour hours may be adjusted to start later or end earlier than the standard racing day based on the exact segment distances and coordination of activities at each of the stages / checkpoints. Actual Tour hours will be announced at the pre-Tour meeting.

### 12.10.B Time Zones

**12.10.B.1** Official clock time for each entry on each stage of the Tour will be based on the local time zone at that stage's start line, as displayed by the Tour Officials. The same official clock time (Tour Time) will remain in effect for each team for the entire stage, even though that stage's route may cross into a different time zone.

**12.10.B.2** Specific guidance on this regulation will be provided by ASC Headquarters with a Route Operations Document.

## 12.11 Tour Route

### 12.11.A Route Book

The American Solar Challenge Route Book will be distributed to each team that qualifies for the Tour. The Route Book will contain information to direct the team along the official route. It will specify days, distances, directions, route numbers, maps, and points of reference. For a team to receive official time, they must follow the official Tour Route.

### 12.11.B Route Revisions

Due to unforeseen events, it may be necessary to detour from the official route. When advance warning is available, Tour Headquarters will correct the official route accordingly and provide revisions to the Route Book to all Tour teams, or provide written revisions at the Briefing or at Checkpoints.

### 12.11.C Teams Departing from the Tour Route

Any team leaving the Tour Route must rejoin the route at the same intersection where they left the route, or they will receive no credit for distance driven beyond that point.

### 12.11.D Emergency Route Revisions

Due to unforeseen events, it may be necessary to detour from the official route (emergency road closures etc.). In the event that a team shall have to deviate from the official route due an unplanned road closure that was not previously communicated to the team, the team shall:

- (1) contact Tour HQ for further instructions;
- (2) follow the published detour and rejoin the official route at the earliest possible position; and,
- (3) document the route taken, the start and end times in the detour from the official route and submit the route to Tour HQ for evaluation.

## 12.12 Stage Starts

Teams are released from the Start Line in 1-minute intervals. Each team's Lead and Chase vehicles must merge with their solar car after it leaves the Start Line. The movement of all vehicles in the Start Line area will be under the control of the Start Line Officials.

### 12.12.A Starting Order

For the first day of the Tour, the starting order will be determined based on performance during the Qualifier. The team highest Official Total FSGP Laps will be first in the starting order. In the event of a tie at the Qualifier, the team with the fastest recorded lap will start first. The remaining start order will be determined by the descending number of Official Total FSGP Laps. For all other Stage Starts, the order is based on the Official Elapsed Time and Official Distance of the previous stage available at 7:00 am of that morning, from shortest to longest. In case of a tie, the first of the tying teams to cross the previous stage's finish line will precede the others in the starting line-up.

### 12.12.B Teams Not Ready

If a team's solar car, lead, and chase vehicles, with drivers in each vehicle, are not in their assigned starting positions at 8:45 a.m., the Start Line Officials may, at their discretion, move all of the following cars up one slot, and the tardy team must move to the end of the starting queue.

- 12.12.B.1** If multiple teams are not ready at the 8:45 a.m. time, those teams will start in the order that they arrive ready to start.

### 12.12.C Official Start Time

Each team will be assigned a tentative start time, which will be distributed to the teams at the Briefing the night before (order may change based on the official time 7:00 am the morning of the start). If the team leaves the starting line at their assigned time, then that becomes their Official Start Time for that day. If the team leaves before their assigned time because the Start Line Officials moved them forward in the queue, then the team's Official Start Time is their actual start time. If the team leaves after their assigned time because they were not ready, then the team's Official Start Time will remain their assigned time.

### **12.12.D Delayed Start**

The start of the Tour, at any stage start, may be delayed if inclement weather or other hazardous conditions appear likely to pose a threat to the solar cars or their drivers. If the start of the Tour is delayed, then all assigned start times for that day will be adjusted accordingly.

### **12.12.E Stage Start Timing Adjustment**

The 1-minute start time interval at the beginning of each stage will be accounted for at the end of the Stage. The Stage close time for each team will be offset to reflect the offset from the nominal start time<sup>9</sup>. Checkpoint close times and end-of-day times will not be adjusted by the Stage Start Timing Adjustment.

## **12.13 Non-Stage Starts**

Solar cars will be released from their start point at 9:00 am, or as adjusted based on the end-of-day grace period from the previous day per Reg. 12.15.

## **12.14 Checkpoints**

A Checkpoint is a mandatory stop (typically 45 minutes) in a predetermined location along the Tour Route. Checkpoints may be added or subtracted as needed by Tour Officials. Checkpoints will remain “active” for a specified number of hours during the first day of any new stage. “Active” hours will be posted and announced at the pre-Tour meeting.

### **12.14.A Active Checkpoints**

Teams reaching an active checkpoint will be subject to a mandatory stop at the Checkpoint. Mandatory time spent in an active Checkpoint will not be factored into a team’s Official Total Elapsed Time. Failure to stop at an active Checkpoint will result in no credit for distance driven beyond that point. Within the Checkpoint area, the movement of all team vehicles shall be under the control of Checkpoint Officials.

### **12.14.B Solar Car Maintenance**

Solar charging of solar car batteries and solar car maintenance are allowed during the mandatory Checkpoint time. Array stands that are carried by the solar car are allowed to be used at checkpoints. Teams must not interfere with or block any other team’s passage through the Checkpoint. Teams unable to leave the Checkpoint area after the mandatory time must move their solar car elsewhere.

### **12.14.C Closed Checkpoints**

After the specified number of active hours, Checkpoints will be permanently shut down and will be referred to as “closed”. Teams are not required to stop at closed checkpoints and should immediately proceed on the Tour Route.

### **12.14.D End of Day at Checkpoint**

Any teams still serving their checkpoint time when the checkpoint closes will be required to finish serving the full duration of the checkpoint. If they are in their grace period, they must declare end of day at the checkpoint location and begin their evening solar charging session.

## **12.15 Overnight Stops<sup>10</sup>**

For days not ending at a Stage Finish, a “grace period” of up to 15 minutes early or 30 minutes late can be applied to the end of each team’s Official Driving Day to allow time to find a safe place to stop. The corresponding time adjustment will be made to the Official Start Time for the next morning. No credit is given for teams choosing to stop more than 15 minutes early. The grace period cannot be applied to a Stage Start or Finish.

---

<sup>9</sup> Example: Team A starts at 9:07 am, their Stage close time will be adjusted by 7 minutes.

<sup>10</sup> Example: Team A elects to drive 17 minutes late to find an appropriate overnight venue. The following morning, their Official Start Time will be 9:17 am. Team B elects to stop driving 7 minutes early. The next morning their Tour Time begins 8:53 am.

## 12.16 Stage Finishes

A Stage Finish marks the completion of a stage and is a mandatory stopping point for all teams in a predetermined location along the Tour Route. A Stage Finish will remain “active” for a specified number of hours. The Stage will open based on the fastest car and will close at a predetermined time, to be announced at the pre-Tour briefing.

Once a team’s solar car crosses the Stage Finish Line the movement of that team’s vehicles shall be under the control of Finish Line Officials. Specific areas will be designated for solar charging, impound, support vehicle parking, and Tour Headquarters. Solar cars may be pushed within and between these areas, but regenerative braking may not be used during such times.

A team’s Stage Finish time will be posted to the ASC Website.

### 12.16.A Teams Arriving After the Stage Finish is Closed

Any team not at the Stage Stop by the close of the Stage Finish Line will be considered to have trailered. Trailering will be considered to have started as of the position where the team is on the route at the Stage Finish Time. Standard trailering penalties will apply even if the car is driven in on solar power.

## 12.17 Impound<sup>11</sup>

**12.17.A.1** All battery enclosures per Reg. 8.4 must be removed from the solar car and kept overnight in an impound box/container that will be secured by the Observer.

**12.17.A.2** Headquarters should be appraised of special issues for impound.

**12.17.A.3** All impound and un-impound times are uncorrected for the stage start 1-minute intervals

**12.17.A.4** Multi-occupant vehicles can request an exemption from removal of the batteries from the solar car as per Reg. 8.4.

### 12.17.B Impound Times

**12.17.B.1** Batteries must be impounded by 8:00 pm each evening and will be released from Impound at 7:00 am the following morning. Teams that do not impound their batteries will be assessed the impound penalty as per Reg. 15.4.M.

**12.17.B.2** Multi-occupant vehicles that elect to charge from an external power source overnight must declare their intent to do so prior to the impound time, and are exempt from impounding their batteries that evening.

### 12.17.C Impound Rules at Stage Locations

**12.17.C.1** After crossing the finish line at the end of a stage, each team will be given 30 minutes to impound their batteries. This time includes moving the solar car to an area designated by the Finish Line Officials, removing the battery pack, placing the batteries in the approved impound box, and having the approved impound box sealed by an ASC Official.

**12.17.C.2** At 6:00 pm the evening before the start of the next stage, the batteries will be released from impound, and the team may charge from then until the regular nightly impound time, as described in Reg. 12.17.B.

---

<sup>11</sup> Impounding of batteries is designed such that all teams will have equal amounts of charging time. This prevents teams that arrive to a checkpoint early from have more charging time than teams that arrive later. Teams should recognize that should the need arise; they will require additional power sources to power or troubleshoot vehicle systems while batteries are impounded.

Impounding Example: Team A crosses the Finish Line at 2:25 pm and will have until 2:55 pm to impound their batteries. Team B crosses the Finish Line at 5:30 pm and must impound their batteries by 6:00 pm at which time their batteries are immediately released for evening charge. Team C crosses the Finish Line at 5:31 pm and will not have to impound their batteries since the 30 minutes allowed to impound would expire at 6:01 pm, after which regular evening charging has already begun.

## **12.18 Charging Areas**

### **12.18.A Staged Stop**

A charging area will be provided for the teams. Internal combustion generators will not be permitted within the charging area. Solar car charging must occur within this designated area, and activities that may disrupt or interfere with charging may not take place in this designated area.

### **12.18.B Non-Staged Stop**

Teams are responsible for choosing appropriate charging areas.

## **12.19 Passing Traffic**

When six (6) or more vehicles are lined up behind a team's chase vehicle, (including other teams' solar car caravans wishing to pass) the team must pull over as soon as safely possible to allow the traffic to pass.

### **12.19.A In Traffic**

Teams need not disrupt their own progress to permit other vehicles to pass when they themselves are traveling at the posted speed limit or trapped behind other traffic.

## **12.20 Traffic Laws**

During the course of the Tour, all state and local traffic laws must be obeyed. Solar cars must observe a maximum speed limit of 104.6 km/h (65 mph), unless restricted by the Officials per Reg. 10.9.B. (Note: while Event organizers may or may not be aware of or enforce specific local regulations, under no circumstances does this imply that jurisdictions will not enforce local ordinances, laws, or regulations.)

## **12.21 Passing Teams**

In the event that one team is overtaken by another, the overtaking team signals their intention to pass by flashing the headlights of their lead vehicle between high and low beam. The overtaking team must also attempt to make CB radio contact with the team being passed to coordinate the pass. Once the overtaking team has signaled their intention to pass, the team being passed must facilitate the pass at the first available safe opportunity, either by slowing down by at least 8 km/h (5 mph) in a zone where passing is permitted and feasible, or by pulling completely out of the traffic lane.

## **12.22 Drafting**

Drafting by a solar car is prohibited. A solar car will be considered to be drafting if it continuously follows behind another vehicle at less than a 3-second interval. The only exception to this is in congested traffic at speeds of 40 km/h (25 mph) or less.

## **12.23 Pushing**

Except for the following situations, solar cars may not be pushed or pulled from the time they are moved into their starting position for the Daily Start until they reach the finish line. In no case shall regenerative braking be engaged while pushing or pulling the solar car.

### **12.23.A Checkpoints / Stage points**

Solar cars may be pushed within the confined area of the Checkpoint or Stage Point.

### **12.23.B Emergency**

In an emergency or breakdown situation, the solar car must be removed from the road as quickly as is prudent. In this circumstance, the car may be pushed or lifted off the roadway. Upon resuming driving, the solar car may then be pushed or lifted back onto the roadway to the same location where it left the roadway.

### **12.23.C Weather**

The solar car may be pushed onto and off of a trailer to protect it from the weather, provided the solar car is moved back to its original location after it is unloaded from the trailer.

### **12.23.D Penalties**

Any pushing outside of the circumstances outlined above that advances the solar car along the route will incur a penalty as per Reg. 15.4.F.



## 12.24 Trailering

### 12.24.A Pushing

Should it become necessary to load the solar car onto a trailer for transport, it may be pushed onto the trailer.

### 12.24.B Battery Charging

Battery charging from the solar collector while trailering is allowed during non-impound hours.

### 12.24.C Trailering to Checkpoints or Stage

Once a team has decided to trailer, they must trailer to either the next open Checkpoint, or the Stage Finish prior to the evening battery impound at 8:00 pm on the day of the Stage Finish. If a team who is trailering to a Checkpoint arrives and the Checkpoint is closed, they must trailer to the Stage Finish as per above.

### 12.24.D Resumption of Driving

Teams may resume driving via one of the following options:

12.24.D.1 At the point they started trailering, or earlier along the route: OR

12.24.D.2 At an open Checkpoint.

### 12.24.E Resumption of Driving at a Checkpoint

Teams who elect to resume driving at a Checkpoint will be released from the Checkpoint at the posted Driving Resumption Time for that Checkpoint.

12.24.E.1 Should multiple teams be resuming driving from the same Checkpoint, teams will be released on one-minute intervals based on arrival at the Checkpoint.

12.24.E.2 A team's arrival at the Checkpoint will be determined by a team representative informing the Checkpoint Staff of their arrival with the solar car. Arrival of support vehicles only will not count. It is the onus of the team to notify the Checkpoint staff of their arrival.

12.24.E.3 Teams released on one (1)-minute intervals will have their Stage Close time corrected in the same manner as that of a Stage Start.

12.24.E.4 A team who is electing to resume driving at the Checkpoint will be considered as "trailing" until the Driving Resumption Time and will not observe the Checkpoint time.

## 12.25 Accommodations and Lodging

All teams are responsible for team accommodations and food during the Tour. Teams are responsible for their own reservations.

## 12.26 Accidents and Re-Inspection

All accidents involving either solar cars or support vehicles must be reported immediately to ASC Headquarters. In the case of an accident involving personal injury notification of the appropriate emergency medical services and public safety officials shall take priority. If a solar car is involved in an accident it must:

- (1) Stop and be visually inspected by team members and the Observer.
- (2) Be re-inspected by an Inspector at or before the next controlled stop (Stage/Checkpoint). The Inspector may require repairs prior to resuming the Tour.

## 12.27 Alterations and Repairs

If a team makes alterations or repairs to the solar car that may affect the safety, handling, or roadworthiness of the solar car, they must report these changes to ASC Headquarters at the next Stage Stop. The alterations/repairs must be inspected before the team is allowed to resume the tour.

## 13. Multi-Occupant Vehicle Judging

### 13.1 Goal

The goal for Multi-occupant vehicles is to efficiently transport people along a predefined route with considerations for practicality while driving at or above the Target Average Speed.

### 13.2 Scoring

Multi-occupant vehicle teams will be ranked according to their S value (highest score is best).

$$S = (D / E) \times P \times C$$

Where D is the Total Person-Mile Distance, E is the Total External Energy usage of the solar car, P is the Practicality Score, and C is the Completion Factor.

If a team's Overall Average Speed is below the Target Average Speed, their score will be multiplied by

$$0.4^{(V-Va)}$$

Where V is the Target Average Speed and Va is the Overall Average Speed.

#### 13.2.A Person-Mile Distance

A team's Person-Mile Distance will be calculated for each Segment of the Event. The Segment Person-Mile Distance is the Tour Distance driven between each stage/checkpoint to the next stage/checkpoint multiplied by the minimum number of occupied seats within the solar car over the driven distance of that Segment. The summation of these Segment Person-Mile Distances will yield a Total Person-Mile Distance for the entry.

#### 13.2.B External Energy Usage

Total External Energy usage of a Multi-occupant vehicle will be calculated as:

$$(n+1) \times Q + M$$

Where n is the number of times unmetered external energy is used to charge the vehicle between the start line and the finish line, and Q is the nominal energy capacity of the energy storage system, and M is the total metered external energy in kWh used to charge the vehicle. The nominal energy capacity of a rechargeable electrochemical battery is the sum of the nominal cell masses in kilograms (kg) multiplied by:

0.330 kWh/kg for Li-S cell

0.250 kWh/kg for Li-ion cell

0.250 kWh/kg for Li-polymer cell

0.125 kWh/kg for LiFePO4 cells

**13.2.B.1** The nominal energy capacity of other types of energy storage system will be determined by the ASC Organizers

**13.2.B.2** When the energy storage system is charged from external sources, it shall be metered per reg 8.10. The energy from all metered external energy charges will be added up to calculate the total metered external energy in kWh. If for any reason an external charge is not properly metered and recorded, it will count as charging from unmetered external energy.

### **13.2.C Practicality Score**

**13.2.C.1** The Practicality Score for a multi-occupant vehicle team will be determined by a panel of judges appointed by the ASC Organizers. It will be based on a mix of subjective and objective evaluations.

**13.2.C.2** Practicality judging will be conducted on the solar cars during the rest day prior to the start of the Tour. The score from each judge will be averaged into the overall Practicality Score for the solar car ranging from 0-1.

**13.2.C.3** The MOV Practicality Judging Rubric will not be released to judges or teams until the morning of the judging.

**13.2.C.4** Example practicality judging aspects are listed in Appendix L.

**13.2.C.5** Teams will be required to prepare a "window sticker" for their solar car which describes the attributes of the car. Teams will provide a digital copy of this "window sticker" to ASC Headquarters for publication through social media on the morning of judging.

**13.2.C.6** Prior to the start of ASC, Officials will review and compile the Practicality Scores for all MOV teams and each team will be provided with their own score along with a copy of each judge's MOV Practicality Judging Rubric evaluation of their vehicle. Practicality Scores of all teams will be made public at the ASC Awards Ceremony at the conclusion of the Event.

### **13.2.D Completion Factor**

The Completion Factor is calculated by:

$(\text{Total Driving Distance in miles} - \text{Penalties in miles}) / \text{Highest Driving Distance of Any MOV Entry}$

### **13.2.E Average Speed**

**13.2.E.1** The Target Average Speed for the Event is 35 miles per hour

**13.2.E.2** The Overall Average Speed will be computed as the total driving distance divided by the total elapsed time over the course of the event, in miles per hour.

## **13.3 Route**

### **13.3.A Completing the Route**

**13.3.A.1** Each Multi-occupant vehicle will need to complete the route. Teams will only receive credit for distance traveled and will not receive any credit for distance which is not covered or distance covered while trailering.

**13.3.A.2** If a Multi-occupant vehicle trailers they will not be awarded any distance for the period trailered.

**13.3.A.3** Multi-occupant vehicles will trailer under the same regulations as trailering for the Tour regulations. Reference Reg 12.24 for trailering regulations.

### **13.3.B Checkpoints and Stage Stops**

Each Multi-occupant vehicle will need to arrive at each checkpoint before it closes in the same manner as outlined in the Tour regulations, Reg. 12.14 and Reg. 12.16.

## **13.4 Solar Car Configuration**

The Multi-occupant vehicle shall remain in the same scrutineered configuration throughout the duration of the Tour. All practicality features shall remain intact throughout the duration of the Tour.

## 14. FSGP/Qualifier Operations

### 14.1 Track Event Format

During ASC event years, the track event portion will serve as both a FSGP event and the Qualifier for the cross-country event (Tour) as outlined in Section 12. Herein, this portion of the event will be named the "Track Event". The Track Event is comprised of three (3) on-track days around a closed-course track.

### 14.2 Determination of Winner

#### 14.2.A Single-Occupant Vehicle

Official FSGP Lap Count will be calculated for each entry based on laps that are completed during Track Event hours. The summation of these laps will yield an Official Total FSGP Lap Count for the entry. Overall placing for the FSGP event will be determined based on the highest Official Total FSGP Lap Count. In the event of a tie associated with the Official Total FSGP Lap Count, the tie breaker will be the team with the lowest lap time.

#### 14.2.B Multi-Occupant Vehicle

The ranking of MOV teams for FSGP shall use the same scoring formula as Reg 13.2 with the following exceptions.

The Practicality Score is removed from the scoring equation.

The Person-Mile Distance is Calculated each lap instead of each Segment. Person-Miles are only awarded for valid laps completed by the solar car and will be calculated by the lap distance in miles multiplied by the minimum number of seats occupied in the solar car during that lap.

### 14.3 Solar Car Configuration

Solar Cars must drive in the same configuration as approved during Scrutineering

### 14.4 Radios / Communication

The team must be in two-way radio communication with the solar car driver at all times. Communications should be maintained between the solar car, the pit area, and the timing area at all times.

### 14.5 Authority

Headquarters reserves the right to cancel the track activity at any time for the Event as a whole or for any particular team.

### 14.6 Safety

#### 14.6.A Safety Equipment

**14.6.A.1** Teams are required to have the safety equipment readily available as outlined in Reg 3.1.B (with exception of the traffic cones and flags as these are applicable for the on-road portion only)

**14.6.A.2** Their battery spill kit must be available in the pit area at all times.

**14.6.A.3** Teams shall have first aid supplies in their pit area at all times.

**14.6.A.4** Any team member in the hot pit or going on the track to assist with a broken-down vehicle must be wearing a safety vest.

#### 14.6.B Support Vehicles

No support vehicles will be allowed on the track without prior consent by track officials.

#### 14.6.C Safety Vehicles

Designated safety vehicles will be driven by an ASC Official(s). If a track safety vehicle is needed, it will attempt to stay in the slow lane of the track. The same rules that apply to passing solar cars also apply to passing the safety vehicle. Teams may pass a static safety vehicle during an active yellow as well as any solar car not moving given the conditions are safe to pass.

## 14.7 Briefings

A Briefing will be held at the start of each Event day. A special meeting may be called in cases of emergency. Attendance at meetings by a team representative and driver(s) is required. Briefing notes and other daily updated will be available at ASC/FSGP Headquarters and posted to the ASC/FSGP website. All official statements, rule interpretations, and special instructions will be contained in these postings.

## 14.8 Timing

### 14.8.A Responsibility

Timing and distance determinations for the Track Event will be the responsibility of ASC Officials. Headquarters will recognize no other timing or distance information.

### 14.8.B Timers

Each team must provide a team member to serve as a timer. This team member must be in radio contact with both the solar car driver and the pit crew. The timer will be paired with a timer from another team, and the two will work together to ensure that every lap is properly recorded. Timing Officials will review all timing data for consistency and accuracy. The timer must report 15 minutes prior to the start of the event. Any laps conducted by the solar car without a timer in place will not be counted.

### 14.8.C Official Time

A master clock providing the "Official Time" will be located near the starting line and timing area. A solar car must cross over the start line to begin and end an official lap. All timers must record lap start/finish times based on the official time displayed.

### 14.8.D Track Hours

The track will be open for driving from 10:00 am – 6:00 pm local time (Day 1) and 9:00 am – 5:00 pm local time for Days 2 and 3.

## 14.9 Starts

### 14.9.A Group Start

Teams are released from the Start Line in a group start. The movement of all vehicles in the Start Line area will be under the control of the Start Line Officials.

### 14.9.B Starting Order

For the first day of the Track Event, the starting order will be determined based on performance scrutineering. On subsequent days the start order will be determined based on the total number of Official FSGP Laps completed thus far for Single-Occupant Vehicles, and the Multi-Occupant Vehicle Score as per Reg 14.2.B.

### 14.9.C Start Line

Solar cars will be released simultaneously from the starting line at the beginning of each day. Teams must report to their starting position 15 minutes prior to the beginning of the start time. Control of solar cars in the start-line area is under the direction of the Start-Line Officials. Teams not ready or who are returning to the track from the cold pit area must wait for a track official to clear them for the starting line and be sequenced into traffic.

### 14.9.D Delayed Start

The start of the Track Event may be delayed if inclement weather or other hazardous conditions appear likely to pose a threat to the solar cars or their drivers. If the start of the Track Event is delayed, then the assigned start time for that day will be adjusted accordingly. The end of the day will not be adjusted.

## 14.10 End of Day

### 14.10.A End of Day

At 6:00:00 pm (Day 1) or 5:00:00 pm (Days 2 and 3) the Checkered Flag will be flown at the Start/Finish line. A team currently on a lap started in advance of the End of Day time will be given the opportunity to complete that lap, provided that the lap time for that final lap is no more than 20% greater than the time for the preceding lap.

## 14.11 Required Laps for ASC Qualification

### 14.11.A Team Qualification

In order to qualify for the ASC on-road portion of the Event, each team shall obtain a minimum number of laps. The required total of distance is:

1. 330 km if achieved in one day
2. Or 495 km if achieved in two consecutive days

The number of laps will be broadcast to the teams at the pre-event briefing based on the configuration of the track being used.

### 14.11.B Driver Qualification

In addition, each driver must obtain a minimum number of laps. The required total distance per driver is 85 km.

### 14.11.C Discretion

At the discretion of the Inspectors and the ASC Organizers, entrants who do not complete the requirements for Qualification may be permitted to participate in the Event. Additional requirements may be imposed on these entrants.

## 14.12 Charging/Impound

All battery enclosures per Reg. 8.4 must be removed from the solar car and kept overnight in an impound box/container that will be secured by the Observer. Headquarters should be appraised of special issues for impound.

### 14.12.A Charging

All solar cars may begin the Track Event with a fully charged battery pack. Once the Track Event begins, charging may only occur using the solar car's array in designated charging areas.

**14.12.A.1** Charging from other sources will result in a penalty associated with Official FSGP laps completed to that point, reference Reg. 15.4.J.

**14.12.A.2** All charging of solar car batteries shall be monitored by a team member. Unattended charging of the solar car batteries is strictly prohibited.

**14.12.A.3** A charging area will be provided for the teams. Internal combustion generators will not be permitted within the charging area. Only solar car charging may occur within this designated area.

**14.12.A.4** Multi-Occupant Vehicles are allowed to re-charge their battery packs as per the procedure and scoring of Regs. 13.2.A and **Error! Reference source not found..**

### 14.12.B Impounding

All registered and sealed batteries must be removed from the solar car and kept overnight in the teams impound boxes/containers that was inspected during scrutineering and will be secured by FSGP Headquarters. Batteries must be impounded by 8:00 pm each evening and will be released from impound at 7:00 am the following morning.

**14.12.B.1** Failure to impound batteries will result a penalty associated with Official FSGP laps completed to that point, reference Reg. 15.4.M.

**14.12.B.2** Multi-Occupant Vehicles who intend on charging their battery packs are exempt from this requirement and will not be assessed the failure to impound penalty.

## 14.13 Driving Procedures

All solar cars will proceed around the course in the prescribed direction at all times. Passing and lane information will be presented at the pre-Track Event team meeting.

### 14.13.A Speed Limit

No solar car shall exceed the maximum speed of 104.2 km/h (65 mph), unless restricted by the Officials per Reg. 10.9.B anywhere on the track. All teams entering the pit area must slow down. A walking pace must be observed at all times in the cold pit area. While in the cold pit area a team member shall walk directly in front of the solar car to ensure that the path is clear and to warn others in the area

### 14.13.B Following Too Closely

No solar car shall follow a proceeding car too closely.

### 14.13.C Pushing

Except for the following situations, solar cars may not be pushed or pulled from the time they are moved into their starting position for the daily start until they reach the finish line except in the cold pit areas. In no case shall regenerative braking be engaged while pushing or pulling the solar car.

**14.13.C.1 Garage Area:** Solar cars may be pushed within the confined areas of the Cold Pit or Garage Area.

**14.13.C.2 Emergency:** In an emergency or breakdown situation, the solar car must be removed from the track as quickly as is prudent. In this circumstance, the car may be pushed or lifted off the track. Upon resuming driving, the solar car may then be pushed or lifted back onto the track to the same location where it left the track.

**14.13.C.3 Penalty:** Should the team push the car on the track, a penalty will be applied as per Reg. 15.4.F.2.

## 14.14 Breakdowns

Any solar car that stops on the track because of mechanical problems, lack of power, or an accident must be moved off the track as soon as possible and prior to any repairs being performed. All teams must carry a tow strap in their solar car at all times. This tow strap will be used to facilitate a tow to the pit area by the safety vehicle, if required. No team support vehicles will be permitted on the track at any time. Team members may not run across the track to their solar car unless permission is granted by a track official. All team members attending to a broken-down car on the track must be wearing a safety vest. At the discretion of the inspectors, any car having a breakdown may be required to be re-inspected for safety and rules compliance

## 14.15 Track Operation

### 14.15.A Flags

Flags will be used to provide trackside instruction to solar car drivers.

**14.15.A.1 Master Flag Position:** The Master Flag Position will be near the starting line and display flag(s) to represent the overall condition of the track. Corner workers will be located at various Flag Positions around the course to display "local" flag conditions.

**14.15.A.2 Green Flag:** Track clear; proceed at your chosen speed. This flag will be displayed at the starting line only.

**14.15.A.3 Static Yellow Flag:** Caution ahead, proceed at your chosen speed, passing is allowed. This flag will be displayed at corners to alert drivers to unusual conditions ahead that do not immediately interfere with the track (such as a car stopped off of the track). The corner worker will be holding the flag in a stationary position.

**14.15.A.4 Active Yellow Flag:** Caution, obstruction on or near track. An active yellow flag means that cars are to slow down and no passing is allowed unless waved around by a track official. The corner worker will be actively waving the flag. The no passing rule will continue to apply until the solar car reaches a Flag Position where no flag is displayed. Whenever an active yellow flag is somewhere on the track, the Master Flag Position will display both the green and yellow flags.

**14.15.A.5 Black Flag:** Return to the pit area immediately. A black flag is given to an individual car at which point the driver must return to the pit area. The black flag will appear at the last corner before pit entry.

**14.15.A.6 Red Flag:** Total stoppage due to major accident or some other reason. All cars must pull to the side and stop where they are on the track without passing. Proceed only when instructed to do so by track officials.

**14.15.A.7 White Flag:** This flag will be displayed at the starting line only at five (5) minutes before the end of day time and signifies that there is less than five (5) minutes remaining in the race day.

**14.15.A.8 Checkered Flag:** This flag will be displayed at the starting line only at the end of day time and signifies that the race day is over, save and except for the stipulation in Reg. 14.10.A.



## 15. Penalties

Any team failing to comply with these Regulations during Scrutineering, the Qualifier/Track Event, or the Tour will be penalized. Penalties range from official warnings to disqualification from the Event. It is the responsibility of the Chief Inspector and/or Track Steward, with input from the other Inspectors and the Observers and track personal, to determine whether an infraction occurred, the severity of the incident, and the appropriate penalty. All penalties will be submitted by the Chief Inspector and/or Track Steward to ASC Headquarters for subsequent posting. Disqualification of a team from the Event requires concurrence of the Event Director. For the on-road portion of the Event penalties will generally be applied to Total Elapsed Time or Total Elapsed Distance on the Official Elapsed Time Sheet on staged days, at the start of non-staged days, or at Checkpoints. For the Track Event penalties will generally be applied to total number of official laps.

### 15.1 Penalty Times/Distance/Laps

#### 15.1.A Penalty Times/Distance (Tour)

All penalty times and penalty distances listed are suggested minimums. Driving conduct penalties (Regs. 15.4.A-15.4.H,) may double with each subsequent infraction. Scrutineering and other technical penalties (Regs. 15.4.J-15.4.I) will normally be the same for each infraction. If the Inspectors believe the teams are deliberately violating traffic or driving regulations for strategic advantage, they may impose more severe penalties up to and including potential disqualification.

#### 15.1.B Penalty Laps (Track Event)

All penalty laps listed are suggested minimums. If the Chief Inspector and/or Track Steward believe the teams are deliberately violating driving regulations for strategic advantage, they may impose more severe penalties. Penalty Laps may be subtracted from the Official FSGP Lap Count.

#### 15.1.C Scrutineering Issues

Scrutineering issues may result in a pre-loss of laps (Track Event), and added time / subtracted distance(Tour) as determined by the Inspectors prior to the beginning of each of the Track Event and on-road portion (Tour). Examples of scrutineering issues include but are not limited to: car size exceeds limits. Typically, these issues are the result of receiving a blue status in any inspection area. Issues within the dynamics area may also result in a reduced speed limit for the solar car on the track or on-road.

#### 15.1.D Posting of Penalties (Tour)

Penalties will be publicly posted by 11:00 pm the night before the start of the next stage. All teams must provide an e-mail address and alternate to ASC Headquarters, which is checked regularly, where penalties can be officially delivered to the team. On the last day of the Tour, penalties per team will be posted no later than 30 minutes after the finish of the Tour or the arrival of a team's car, whichever is later.

#### 15.1.E Posting of Penalties (Track Event)

Penalties will be publicly posted by 8:30 pm each evening. On the last day of the Track Event, penalties will be posted no later than 30 minutes after the finish of the Track Event.

### 15.2 Protests

Each team shall designate a single individual that shall act on behalf of their team to submit protests. Any team desiring to file a protest must do so by submitting an official protest to ASC Headquarters. Protests may be filed for any reason, including disputing a penalty levied against any team, correcting timing errors, or protesting the actions of another team. A "filing fee" of 10 minutes (Tour) / 5 laps (Track Event) will be assessed against the team's Official Elapsed Time / Official FSGP Lap Count for the day on which the protest is filed. The Jury will hear all protests.

#### 15.2.A Opportunity to Be Heard

Protests will normally be heard by the jury at the earliest possible jury sitting. It may be necessary in some instances for the jury to postpone the hearing on a protest.

### **15.2.B Time Limit (Tour)**

Except for the last day, all protests against penalties must be filed by 9:00 am the following day the penalty is posted. Protests that do not directly relate to a penalty must be filed by 6:30 pm on the last day of the stage when the offense occurred. On the last day of the Tour, protests for any purpose must be filed within 60 minutes after the finish of the Tour or 60 minutes after a team arrives, whichever is later.

### **15.2.C Time Limit (Track Event)**

Except for the last day, all protests must be filed by 8:00 am the following day the penalty is posted. On the last day of the Track Event, protests for any purpose must be filed within 60 minutes after the finish of the Track Event.

### **15.2.D Protest Judgements**

The decision of the Jury is final and no further appeals are allowed. The Jury will notify ASC Headquarters of their decision, and the Chief Inspector and/or Track Steward or delegate will then inform the affected teams. The Jury may refund some or the entire filing fee, which will be credited to the day the filing fee was assessed.

## **15.3 Conduct**

Penalties, including disqualification from the Event, may be imposed for improper conduct or the use of alcohol or illegal substances. Improper conduct may include, but is not limited to, improper language, unsportsmanlike conduct, unsafe behavior, or cheating. Teams are responsible for the conduct of all persons associated with the team, whether or not they are officially registered.

## **15.4 Penalties**

The following outlines the time, distance and lap penalty values. For each category the penalty is indicated as: time (lap count) for the Tour (Track Event) respectively.

For Multi-Occupant Vehicles the following penalties will be based on a single person-mile penalty (15.4.D, 15.4.G, 15.4.J., 15.4.K, 15.4.L, 15.4.M, 15.4.N, 15.4.O, 15.4.P, 15.4.Q, 15.4.R., and the following penalties will be applied with a multiplier equal to the number of occupants in the car when the infraction occurred (15.4.A, 15.4.B, 15.4.C, 15.4.E, 15.4.F, 15.4.I, 15.4.S)

### **15.4.A Speeding**

**15.4.A.1 Tour:** Any solar car found to be speeding will be penalized. Speeding penalties may be assessed based on the following factors: (1) velocity over posted speed limits, (2) length of time of speeding infraction, (3) location of speeding infraction (i.e. work zones, school zones, etc. where typical penalties would be doubled automatically). The speed of either the solar car itself or the chase vehicle may be used in determining a speeding infraction. The penalty will be a minimum of 1 mile deducted from the team's Official Distance. Speeding infractions including a rate of speed of 112.6 km/h (70 mph) or greater will result in a 60 minute penalty in addition to the calculated assessment.

**15.4.A.2 Track:** Any solar car found to be speeding shall be penalized. Speeding penalties may be assessed based on the following factors: (1) velocity over speed limit, (2) length of time of speeding infraction. Penalties will be assessed with a loss of a lap multiplied by the infraction count for that specific instance. Speeding infractions including a rate of speed of 112.6 km/h (70 mph) or greater will result in a 12 lap penalty.

### **15.4.B Traffic Violations**

**15.4.B.1 Traffic Violations:** Any solar car committing a traffic violation may be penalized, up to disqualification. Any solar car driver who commits three (3) traffic violations (including speeding) over the course of the Tour may be individually disqualified from the Event.

**15.4.B.2 Traffic Violations by Support Vehicles:** if a support vehicle is observed to be committing a traffic violation may result in a penalty applied to the team.

**15.4.B.3 Track Operation Violations:** Any solar car committing a track operation violation may be penalized, up to disqualification. Any solar car driver who commits three (3) traffic violations (including speeding) over the course of the Tour may be individually disqualified from the Event.

### **15.4.C Failure to Allow Other Traffic or Solar car to Pass**

Any team solar car caravan that fails to properly facilitate passing by traffic or other teams may be penalized a minimum of 5 miles (2 laps).

### **15.4.D Support Vehicles Impeding Tour**

Any support vehicles too close to solar car caravans or impeding another team's solar car caravan will be penalized a minimum of 5 miles.

### **15.4.E Drafting**

A minimum 2 mile (1 lap) penalty may be assessed for any time a solar car drafts behind another vehicle.

### **15.4.F Pushing**

**15.4.F.1** A 1 mile penalty for every 15 seconds a team pushes may be assessed each time a team pushes or pulls their solar car in order to advance along the Tour Route. (Except in the exclusions as per Reg. 12.23)

**15.4.F.2** a loss of the current lap will result each time a team pushes or pulls their solar car in order to advance along the track. (Except in the exclusions as per Reg. 14.13.C)

### **15.4.G Improper Ballast**

A 30 mile (6 lap) penalty may be assessed each time a team operates their solar car with ballast that does not match the solar car occupant.

### **15.4.H Unauthorized Drivers / Occupants**

**15.4.H.1** Any solar car that is driven with an unauthorized driver or contains an unauthorized occupant will be required to return to the starting point of the infraction and drive with an authorized driver or authorized occupant in order to receive credit for driving beyond that point.

**15.4.H.2** Any solar car that is driven on the track with an unauthorized driver or contains an unauthorized occupant will forfeit double the number of laps driven with said driver / occupant

### **15.4.I Driving Outside of the Event Day**

Teams that drive beyond 30 minutes past their Official Stop Time will be penalized two (2) miles for every (1) minute beyond that limit.

Teams that start driving earlier than their Official Start Time will be penalized two (2) miles for every (1) minute in advance of that time.

### **15.4.J Non-Solar Charging of Batteries**

After the start of the Track Event / Tour until the official finish, teams will be disqualified from the Event for charging their solar car's storage batteries from any source other than those allowed by Reg. 8, without specific written instruction from Tour Officials. Such charging of a solar car storage battery will constitute replacement and is subject to Reg. 15.4.L.

Multi-occupant vehicles are exempt from this penalty.

### **15.4.K Disturbing Official Battery Seals**

Solar car batteries will be marked with an official seal. Disturbing these seals in a manner that prevents proper identification by Inspectors may be penalized as though all of the battery modules affected had been replaced as in Reg. 15.4.L.

### 15.4.L Replacement of Batteries

Decisions to exchange (or externally recharge – see Reg. 15.4.J) all or part of a battery must be communicated formally to the team's Observer or an Inspector. The penalty will be computed as follows:

$$\text{Time penalty (miles)} = 480 \times (n+S) / N$$

where:

n = number of replacement modules

S = sum of all modules previously replaced

N = total number of modules in solar car battery pack

$$\text{Lap penalty} = 96 \times (n+S) / N$$

where:

n = number of replacement modules

S = sum of all modules previously replaced

N = total number of modules in solar car battery pack

### 15.4.M Failure to Impound

A 2 mile (1 lap) penalty may be assessed for every minute that the team fails to Impound their batteries.

### 15.4.N Exceeding Size Specifications

Oversized solar collectors will be penalized 15 mile (3 laps) per Tour day (per Track Event day) per excess 1000 cm<sup>2</sup> beyond the allowed size specification. Oversized solar cars will be penalized 7 miles (1 lap) per Tour day (per Track Event) per excess 1000 cm<sup>2</sup>. If both the array and car are oversized, both penalties will be applied. Each penalty will be pro-rated if the oversize area for body or array is less than 1000 cm<sup>2</sup> with a minimum of 2 miles per day (2 laps per day) for oversized solar collectors, and a minimum of 1 mile per day (1 lap per day) for oversize solar cars.

### 15.4.O Securing of Fasteners

Failure to comply to Reg. 10.4.B Securing of Fasteners will result in a penalty of 1 mile per bolt (1 lap per 3 bolts, rounded up) per Tour day (Track Event day) per instance where proper securing is not applied. The head mechanical inspector shall determine which non-compliant fasteners must be brought into compliance with Reg. 10.4.

### 15.4.P Parking Brake Penalty

A 5 mile (1 lap) per Tour (Track Event) day penalty will be applied for a non-functioning parking brake based on Reg. 10.6.

### 15.4.Q Roll Cage Clearance Penalty

A 2 mile (1 lap) per Tour (Track Event) day penalty will be applied for each centimeter of clearance lacking between the roll cage padding and a driver's helmet based on Reg. **Error! Reference source not found..** It will be at the discretion of the Inspectors whether less clearance will be allowed with application of the penalty.

### 15.4.R Overweight Battery Penalty

A per day penalty will be applied as per the following equation for battery packs that are overweight as per Reg 8.2.A:

$$\text{Time penalty (miles)} = 200 * (n-N) / N$$

where:

n = battery weight;

N = allowable battery weight

$$\text{Lap penalty} = 40 \times (n+S) / N$$

where:

n = number of replacement modules

S = sum of all modules previously replaced

N = total number of modules in solar car battery pack

### 15.4.S Ignoring BPS Fault Indicator

A 2 mile (1 lap) per Tour (Track Event) penalty will be applied for each occurrence that the team ignores the

BPS Fault Indicator and continues to drive along the route.

## Appendix A. Steering Wheel Specifications

© 2006/08 with acknowledgement to Japanese Automobile Federation

To reduce the possibilities of driver injury in the event of collision and to minimize impediments to emergency egress, the steering system must be controlled by a steering wheel which has a continuous perimeter.

A circular shape is preferred, however the upper part above 2/3 and/or the lower part below 2/3 of the circumference of the steering wheel may be flat as depicted in the diagram below).

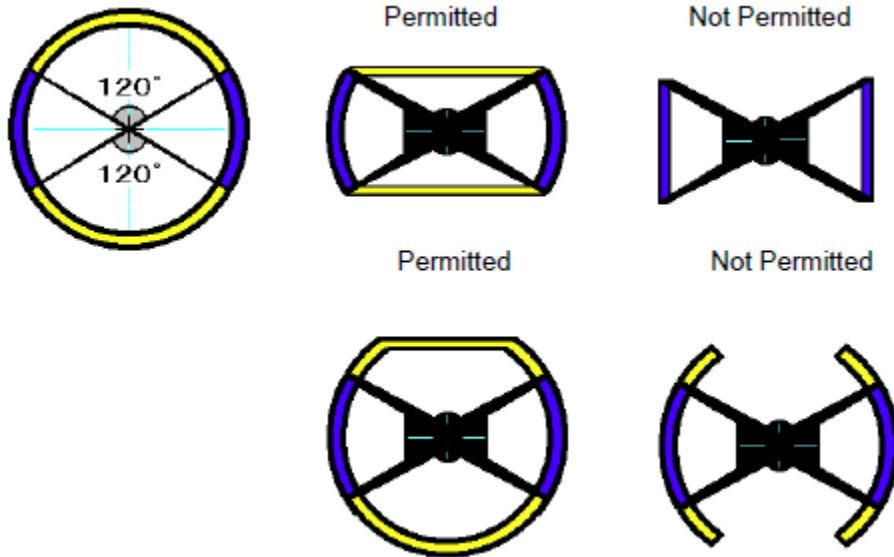

# Appendix B. Occupant Space Diagram

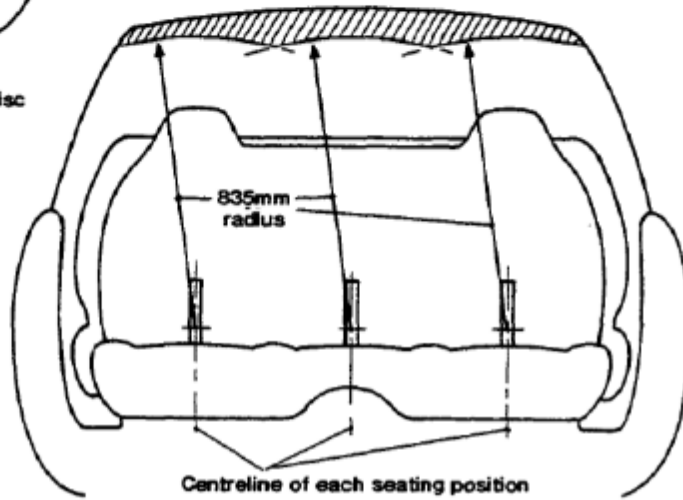
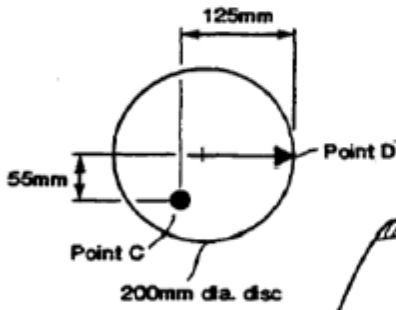
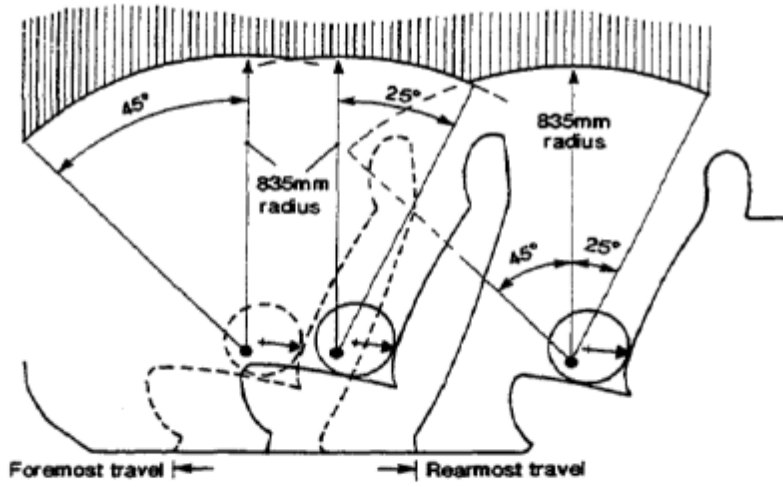

## **Appendix C. Reference Standard for Lighting**

Reference Reg. 9.4.

The reference standard lights are:

TruFLEX

20 LED (Length 3.35 in)

Item TF20 from Custom Dynamics

Red lights are Red LED with Red lens

Amber lights are Amber LED with Amber lens

([www.CustomDynamics.com](http://www.CustomDynamics.com) 1-800-382-1388)

White lights are TF6WC for the BPS Fault Indicator Light and Daytime Running Lights/Headlights

The reference standard lights will be used in the following manner:

Lights shall be powered by a 12 volt power source

Light shall be centered on a flat surface with a matte white finish of 11" x 8.5".

Separate light boards shall be used for each color type as the standard reference.

Reference standard light boards shall be set aside of car to compare during inspections.

## Appendix D. PVDR - Instructions

It is the intent of the Event to maintain the safest entries possible while encouraging a wide variety of designs and materials for solar-powered vehicles. The purpose of the structural report is to require each team to document, by calculation or testing, the structural integrity of their vehicle and the protection provided to their drivers. Note that each team is responsible for the safety of its members, and any minimum criteria specified by the Organizers should not be construed as design specifications for the construction of a "safe" solar vehicle.

The Preliminary Vehicle Design – Mechanical and Electrical report as per Reg. 5.1 should outline the basic mechanical, structural, electrical and battery design of the vehicle. It should be written to be as concise as possible, limited to a total of 20 pages. The report shall be submitted in PDF format, and the text have at least 10-point font.

Report format shall be a single PDF Package containing: (1) technical document on your mechanical system, and (2) an overview of the electrical approach to the solar vehicle. PDF Package file names shall contain sponsoring organizations name\_ASC 2020PVDR. Example: a report from the University of ACME may appear as "UnivOfACME\_ASC2020PVDR.pdf" with the first letter of each new word capitalized and common abbreviations accepted.

The report should describe:

### D.1 Mechanical:

Teams shall submit the mechanical reports following the form ( Appendix E ) provided using the form as a cover page and table of contents to the report.

This form provides a format for the preliminary vehicle design report that must be completed in its entirety and included as the first page of the report.

### Mechanical Loading Conditions

Teams shall consider road and traffic conditions when determining loading criteria and potential failure modes. For suspension and steering systems, analysis shall include a minimum of **1G turn, a 2G bump, and 1G braking** case loads with a worst-case condition of the loads combined. These loads shall to be applied at the **wheel patch** where the tire makes contact with the ground. Loads shall be provided in dimensional units, along with any relevant assumptions used in the analysis.

### D.2 Electrical & Battery:

- (1) An overview of the electrical approach to the solar vehicle
- (2) Electrical Team leader contact information (phone & email)
- (3) A preliminary electrical diagram showing greater than 24-volt service plans.
- (4) Preliminary battery approval document including the battery team leader contact information (phone & email)
- (5) Battery types and suppliers/manufacturers' being considered if one is not already chosen
- (6) Battery testing plans with critical dates.
- (7) Battery Cell Manufacturing URL



# Appendix E. Mechanical PVDR Form



# ASC2020 Mechanical PVDR Form

School/Team: \_\_\_\_\_ Entry # \_\_\_\_\_

## Mechanical PVDR/Table of Contents

- 1. History of team and vehicle (one paragraph) page \_\_\_\_\_
- 2. **Type of vehicle:** Single-Occupant (\_\_\_), Multi-Occupant (\_\_\_) check one
- 3. Vehicle weight (estimate) (\_\_\_\_); Units (\_\_\_) kg (\_\_\_) lbs,
- 4. Vehicle description shall be presented by profile and top view drawings showing the placement of major components such as driver, battery, ballast box, crush zone, seat belts mounting points, etc, along with overall dimensions including wheel base and tread page \_\_\_\_\_
- 5. **Frame/chassis and roll cage type:** tubular frame (\_\_\_), composite (\_\_\_), check one. Drawing shall show the driver positioned in the frame/chassis, compliance with Reg. **Error! Reference source not found.**, 10.3.B, 10.3.C, and description of method of construction page \_\_\_\_\_
- 6. **Roll cage:** Profile and frontal drawings shall show compliance with Regs 10.3.A page \_\_\_\_\_
- 7. **Seat Belts:** 5 point (\_\_\_), 6 point (\_\_\_), check one Drawing shall indicate location of mounting points and compliance with Reg. 10.3.E page \_\_\_\_\_
- 8. **Braking system:** Front wheel only (\_\_\_), Front-rear (\_\_\_), check one. Schematic and description of primary braking system shall show compliance with Regs. 10.5 and 10.6 page \_\_\_\_\_
- 9. **Steering system type:** rack and pinion (\_\_\_), other (\_\_\_), check one. Description shall include component selection and specs page \_\_\_\_\_
- 10. **Front suspension:** type: a-arm (\_\_\_), other (\_\_\_), check one Description shall include drawing/photos, component selection and engineering analysis demonstrating proper selection and sizing of rod ends with shear loads page \_\_\_\_\_
- 11. **Rear Suspension:** type: a-arm (\_\_\_), swing arm (\_\_\_), other, check one. Description shall include drawing/photos with component selection and specs, and engineering analysis demonstrating proper selection and sizing of rod ends with shear loads page \_\_\_\_\_
- 12. Description of method of analysis to be used to prove structural integrity For loading conditions as per Appendix D, Section D.1 page \_\_\_\_\_

Mechanical contact: Name: \_\_\_\_\_  
 Email address: \_\_\_\_\_  
 Phone: \_\_\_\_\_

Project Manager: Name: \_\_\_\_\_  
 Email address: \_\_\_\_\_

## Appendix F. Mechanical Report Instructions

It is the intent of the Event to maintain the safest entries possible while encouraging a wide variety of designs and materials for solar-powered vehicles. The purpose of the structural report is to require each team to document, by calculation or testing, the structural integrity of their vehicle and the protection provided to their drivers. Note that each team is responsible for the safety of its members, and any minimum criteria specified by the Event should not be construed as design specifications for the construction of a "safe" solar vehicle.

The structural report shall be presented in the format described in this document. Reports that do not meet this format will not be read and could jeopardize a team's chances for competing in the Event. The report should be written to be as concise as possible and should only present information relevant to the requirements of the report. The report is limited to a total of 30 pages, including appendices and submitted in PDF format.

### F.1 Report Presentation

Teams shall submit the mechanical reports following the form ( Appendix G ) provided using the form as a cover page and table of contents to the report.

This form provides a format for the vehicle design report that must be completed in its entirety and included as the first page of the report.

### F.2 Loading Conditions

Teams shall consider road and traffic conditions when determining loading criteria and potential failure modes. For suspension and steering systems, analysis shall include a minimum of **1G turn, a 2G bump, and 1G braking** case loads with a worst-case condition of the loads combined. These loads shall to be applied at the **wheel patch** where the tire makes contact with the ground. Loads shall be provided in dimensional units, along with any relevant assumptions used in the analysis.

### F.3 Vehicle Impact Analysis

The vehicle impact analysis section must include the following topics:

**F.3.1 Specifications:** The report must describe the vehicle frame and construction techniques (aluminum space frame, composite monocoque, etc.), including the materials utilized, their important dimensions (e.g., tubing diameters and thicknesses, number and types of plies in composite constructions), and their properties (in the "as welded" or "as fabricated" condition). The report must also list the specific impact criteria that are assumed for each case, as well as sample calculations and computer output as applicable. Other relevant assumptions used in the analysis should be listed.

**F.3.2 Drawings:** The report must include structural drawings of the vehicle from five viewpoints: top, front, side, rear, and isometric. These drawings must illustrate the following:

- Driver location and orientation
- All members considered "structural"
- Locations of ballast and batteries
- Locations of chassis hard points (points of attachment).
- Calculated center of mass

The report must contain structural drawings of the driver's compartment from three viewpoints: top, front, and side. These drawings must illustrate the following:

- Driver location
- Crush Zone
- Roll cage design and location
- Location of structural members
- Driver's harness attachment points

The report must contain an isometric drawing of the body and solar collector. All drawings must be identified by number and must include a description.

**F.3.3 Analysis:** Analyzes may be in the form of computer modeling (such as a finite-element analysis) or empirical testing of the actual vehicle or its components. The report must document the performance of the vehicle regarding front, rear, side, and rollover impact, using appropriate forms of analysis. Front, rear, and side impact with another vehicle assumes a bumper height of 100 mm and elevation off the ground of 350 mm as shown in Figure 1. Rollover analysis must address loads at a minimum vertical and

two increments between horizontal and vertical.

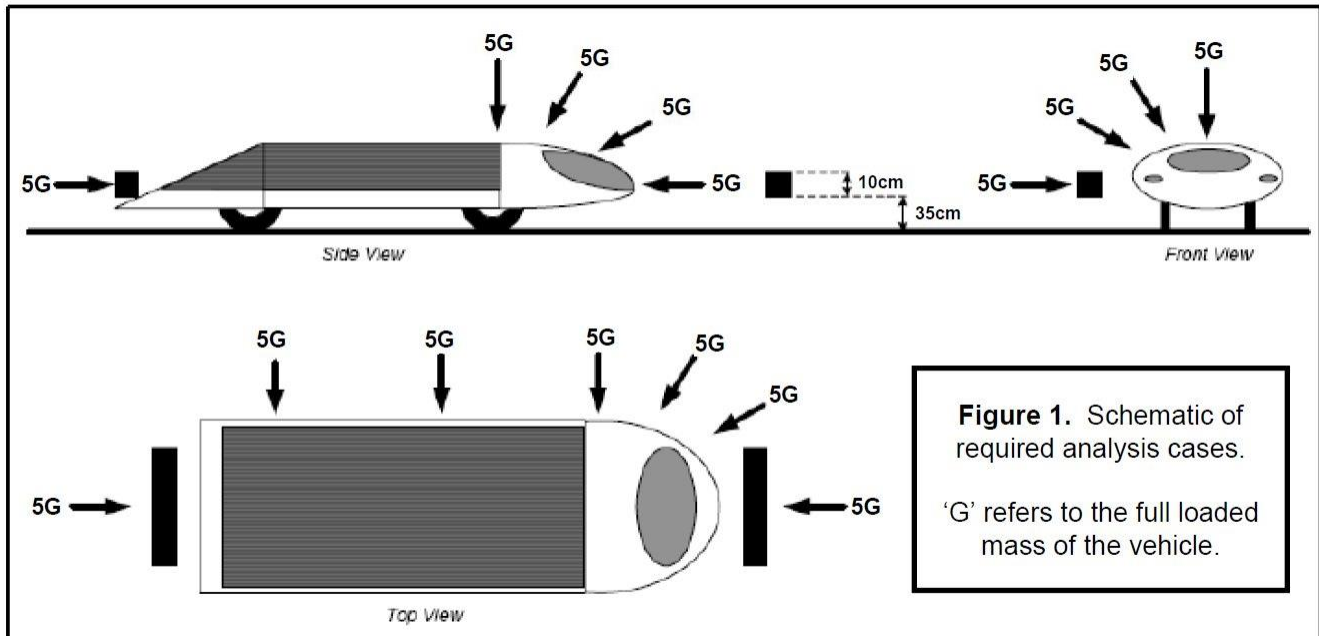

The minimum criteria for these impacts are 5G loads, where the G is the total gross mass of the vehicle (including driver and ballast) as illustrated in Figure 1. Emphasis should be placed on how protection is provided for the driver under these conditions. All impact scenarios must take into account movement of body panels and the vehicle's solar collector to ensure that these members do not penetrate the space occupied by the driver during the impact.

**F3.4 Conclusions:** The report should contain a summary of the findings for each impact case and a brief discussion of the results. Raw data should be attached as an appendix to the report.

#### F.4 Appendix

The appendix should only include relevant information that is referenced from the main body of the report. Appendix items should be organized into two appendices. Examples of what could possibly be included in the appendices are: detailed calculations and results, empirical testing data, details on construction techniques, and component specifications that are particularly relevant to the analysis.

- **Appendix A** - Mechanical Systems Analysis Supporting Documentation
- **Appendix B** - Vehicle Impact Analysis Supporting Documentation

# Appendix G. Mechanical VDR Form



## ASC2020 Mechanical VDR Form

School/Team: \_\_\_\_\_ Entry # \_\_\_\_\_

### Mechanical VDR/Table of Contents

1. History of team and vehicle (one paragraph) page \_\_\_\_\_
2. **Type of vehicle:** Single-Occupant (\_\_\_), Multi-Occupant (\_\_\_) check one
3. Vehicle weight (estimate) (\_\_\_\_); Units (\_\_\_) kg (\_\_\_) lbs,
4. Vehicle weight distribution (estimate), front (\_\_\_\_), rear (\_\_\_\_), lbs/kg.
5. Vehicle description shall be presented by profile and top view drawings showing the placement of major components such as driver, battery, ballast box, crush zone, seat belts mounting points, etc, along with overall dimensions including wheel base and tread page\_\_\_\_\_
6. **Frame/chassis and roll cage type:** tubular frame (\_\_\_), composite (\_\_\_), check one. Drawing shall show the (1) occupants positioned in the frame/chassis, (2) material specs of all metal components, and (3) compliance with Reg **Error! Reference source not found.** page\_\_\_\_\_
7. **Roll cage:** Profile and frontal drawings shall include material specs and show compliance with Regs **Error! Reference source not found.**,10.3.B,10.3.C page\_\_\_\_\_
8. **Seat Belts:** 5 point (\_\_\_), 6 point (\_\_\_), check one page\_\_\_\_\_
9. **Braking system:** Front wheel only (\_\_\_), Front-rear (\_\_\_), check one. Schematic and description of primary braking system shall include parking brake and component specs demonstrating compliance with Regs.10.5 and 10.6 page\_\_\_\_\_
10. **Steering system type:** rack and pinion (\_\_\_), other (\_\_\_), check one. Description shall include component selection and specs page\_\_\_\_\_
11. **Steering stops:** Description/drawing/photos shall show compliance with Reg 10.7.B. page\_\_\_\_\_
12. **Front suspension:** type: a-arm (\_\_\_), other (\_\_\_), check one Description shall include drawing/photos, component specs, and engineering analysis demonstrating proper selection and sizing of rod ends with shear loads under applied loads as specified in Appendix F, section F.2 page\_\_\_\_\_
13. **Rear Suspension:** type: a-arm (\_\_\_), swing arm (\_\_\_), other, check one. Description shall include drawing/photos, component specs, and engineering analysis demonstrating proper selection and sizing of rod ends with shear loads under applied loads as specified in Appendix F, section F.2 page \_\_\_\_\_
14. **Tires and rims:** Description shall include brand, load, speed, and pressure rating to comply with Reg. 10.2 page\_\_\_\_\_
15. **Hub design:** Drawings showing wheel-hub assembly page\_\_\_\_\_
16. **Battery box:** Description/drawing to show how battery box is constructed and secured in the chassis as per Reg. 8.4.B page\_\_\_\_\_
17. Description/drawing to show independent methods of array attachment as per Reg. 10.1.C page\_\_\_\_\_
18. **Fasteners:** Description of compliance with Reg. 10.4 page\_\_\_\_\_

19. **Vehicle Impact Analysis:** Method: Classical (\_\_\_), FEA (\_\_\_), Testing (\_\_\_)  
Analysis shall be performed as per Appendix F Section F.3 and the results shall be presented in terms of factor of safety in tabulated form

page\_\_\_\_\_

-----

Mechanical contact: Name: \_\_\_\_\_  
Email address: \_\_\_\_\_  
Phone: \_\_\_\_\_  
Project Manager: Name: \_\_\_\_\_  
Email address: \_\_\_\_\_

\_\_\_\_\_  
*Professional Engineer Signature*

\_\_\_\_\_  
*Printed Name*

\_\_\_\_\_  
*Phone Number*

\_\_\_\_\_  
*Email Address*

\_\_\_\_\_  
*Date*

# Appendix H. Battery Approval Form



## ASC2020 Battery Form

**NOTE:** The manufacturer's specification sheet, the battery's MSDS sheet with accident protocol, and a description of the protection circuitry (protection circuitry schematic, high level description, list of items protected) must also be submitted to ASC prior to approval. Battery approval is subject to verification at Scrutineering. If the manufacturer changes the battery's specifications, the new specifications must be submitted for re-approval. Teams should bring unmodified cells for weight verification.

### CONTACT INFORMATION

Date: \_\_\_\_\_ Team Number: \_\_\_\_\_  
 Organization: \_\_\_\_\_ Team Battery Contact Email: \_\_\_\_\_  
 Team Email: \_\_\_\_\_ Phone: \_\_\_\_\_

### MANUFACTURER INFORMATION

Manufacturer: \_\_\_\_\_ Type (LION, etc): \_\_\_\_\_  
 Manufacturer URL: \_\_\_\_\_ Model Number: \_\_\_\_\_  
 Battery Name: \_\_\_\_\_ Charge Rate: \_\_\_\_\_  
 Battery Capacity (Ah): \_\_\_\_\_ Cell Voltage: \_\_\_\_\_  
 Battery Mass (kg): \_\_\_\_\_ Max Discharge Current per Cell: \_\_\_\_\_  
 Battery Cost (US\$): \_\_\_\_\_

### VEHICLE BATTERY PACK SPECIFICATIONS

Number of batteries in the vehicle battery pack : \_\_\_\_\_  
 Pack Mass (kg): \_\_\_\_\_ Pack Voltage: \_\_\_\_\_  
 Pack Configuration: \_\_\_\_\_

### SUPPLIER INFORMATION

Information for the company that is supplying the batteries to the team. This may be the original manufacturer or a reseller. If the supplier uses a different model name or number than the manufacturer, please provide that information.

Supplier: \_\_\_\_\_ Contact: \_\_\_\_\_  
 Email: \_\_\_\_\_ Phone: \_\_\_\_\_  
 Supplier Battery Name: \_\_\_\_\_ Supplier Model #: \_\_\_\_\_

**Note:** For this form, the term "battery" refers to the smallest single unit produced by the manufacturer. A lithium ion battery usually contains one cell. Teams or suppliers may group batteries together to form "modules". The term "battery pack" refers to the full vehicle battery system made up of multiple batteries.

## Appendix I. Solar Cell Report

Your report will be based on the type of solar collector you intend to use in the ASC 2020 Event based on Reg.8.1. The following are instructions on preparing your team's report. Prepare your report using the instruction set that matches your solar car entry's style of array.

Your report should contain the following:

- (1) Team Name
- (2) Team Number
- (3) Array type (Silicon only, Ga/As only, or mixture) based on Reg. 8.1.E
- (4) Complete list of cells used on your solar collector. List should indicate (Reg. 5.2.F) for each unique type of cell used:
  - a. Cell manufacturer's name and contact info
  - b. Stock number, type, or description
  - c. Manufacturer's quote for cell area (square centimeters)
  - d. Manufacturer's quote for performance
  - e. Cell area (square centimeters)
  - f. Include a copy of the manufacturer's data sheets in the appendix of your report for each type of cell. *NOTE: you are only allowed a maximum of 6 types of cells. Any change in any of the cell characteristics would dictate a new cell type being used.*
- (5) A detailed breakdown of the size and dimensions of each type of cell listed in #4 after trimming or cutting as placed on the solar car. Show your calculations on how you determined cell area. Cell area should be in square centimeters (Reg. 5.2.F.6).
- (6) A detailed drawing showing the specific layout of your solar collector including how the array is broken into sub arrays and the layout for each solar cell indicating which type of cell is used where on the array (Reg. 5.2.F.7).
- (7) Calculations determining the total cell area for your whole solar collector. Show your calculations and use square centimeters (Reg. 5.2.F.7).
- (8) Indicate all other non-photovoltaic/ photovoltaic technology used as defined in Reg. 8 Report how these technologies will be used during driving and charging times. Indicate how these technologies will fit into the car volume allowed per Reg 9.1.

### **All calculations should be reproducible by inspectors.**

The purpose of these reports is to pre-scrutineer your car's solar collector. Inspectors will compare your report to your car at Scrutineering. Be sure to remember to bring a sample raw solar cell (Reg. 8.1.G) of each type used to Scrutineering for validation purposes.

## Appendix J. Solar Cell Approval Form



# ASC2020 Solar Cell Approval Form

Email completed form to [asc teams@americansolarchallenge.org](mailto:asc teams@americansolarchallenge.org). The manufacturer's specification sheet also needs to be submitted.

Team Information	Date Submitted	
	Team Number	
	Organization/School	
Team Array Contact	Name	
	Phone	
	Email	
Manufacturer's Specifications	Manufacturer	
	Manufacturer Contact POC, Phone, & Email	
	Type	
	Cell Name	
	Cell Model Number	
	Area of Single Cell (cm <sup>2</sup> )	
Complete at Least Three of the Following Spaces Based on Manufacturer's Specifications	Vmp (Volts)	
	Imp (Amperes)	
	Pmp (Watt)	
	Efficiency (Percent)	
Vehicle Array Specifications	Cell Area After Trimming for Placement on Car (cm <sup>2</sup> )	
	Number of Cells in Array	
	Total Array Photovoltaic Area (m <sup>2</sup> )	
	Additional Comments	
Supplier Information	Supplier	
	Contact Person	
	Phone	
	Email	
	Supplier Cell Name	
	Supplier Cell Model Number	



## Appendix K. Recommendations

These are not binding parts of the regulations, as they are impractical to enforce fairly, but the ASC officials believe they are essential to creating a good, safe solar car. All teams should meet these recommendations on their own.

**Driver Training:** Driver Training is essential to ensuring your car can be driven safely. Solar vehicles have substantially different controls, field of vision, and feedback from regular vehicles. We recommend that every team trains all drivers in a gradual and controlled manner. This means that a driver will begin learning to handle the vehicle in a very controlled setting (such as a large closed parking lot or track) and progress to more challenging situations as he/she gains experience. Prior to any driving, the vehicle should always be given a safety check and the driver should have properly functioning safety equipment. As training progresses, the driver (and all team members in the caravan) should practice handling the following situations:

- (1) Blow-outs and run flats, especially of the single rear wheel on a three-wheel vehicle
- (2) Loss of power
- (3) Primary brake partial and complete failure
- (4) Passing protocols
- (5) Merging protocols
- (6) Road hazard avoidance
- (7) Moving to shoulder from operational speed
- (8) Caravan communication and protocols for possible emergencies
- (9) Emergency stop and egress

**Vehicle Stability and CG:** CG location has an important influence on vehicle stability. Your CG location should be a design requirement, not something you find after you build the car. Information about recommended CG location, and its influence, will be posted on the ASC website.

**Wheel Base / Width Ratio:** It is recommended that the wheel base to width ratio be greater than 1.5.

## **Appendix L. Multi-occupant Vehicle Practicality Judging**

The following is an example list of areas that may be considered for the determination of the practicality scoring for the solar car.

This list is not intended to be comprehensive, additional items may be considered, and not all items may be included in the final scoring.

Driver and Occupant Amenities

Quality of Features

Infotainment System

Phone Connectivity

Ease of Operation

Internal and External Styling

Fit & Finish

Watertight Cabin

Visibility

Seats

Doors

Cargo Space

Spare Tire Kit

Never go  
above  
horizontal.

# Appendix M. Revision Table

Rev	Description	Date
A	Initial Release of Document	February 1, 2017